

ROUNDPOINT II

EIN- BZW.
ZWEIFUNKTIONSLEUCHTE

SINGLE RESP. DOUBLE
FUNCTION LAMP



aspoeck.com



PRODUCT INFO





ROUNDPOINT II

EIN- BZW. ZWEIFUNKTIONSLEUCHTE
SINGLE RESP. DOUBLE FUNCTION LAMP



FEATURES

ADR Zone 2 IP 6K9K

NEUE GENERATION DER ROUNDPOINT
NEW GENERATION OF ROUNDPOINT

EIN- BZW. ZWEIFUNKTIONSLEUCHTE
SINGLE RESP. DOUBLE FUNCTION LAMP

ALS LED ODER GLÜHBIRNEN LEUCHTE
AVAILABLE IN LED OR BULB

DURCHMESSER = 70
DIAMETER = 70

BEFESTIGUNG DURCH CLIPS
FIXATION WITH CLIPS

LED UND GLÜHBIRNENVERSION KANN BELIEBIG MITEINANDER KOMBINIERT WERDEN
LED AND BULB CAN BE MIXED

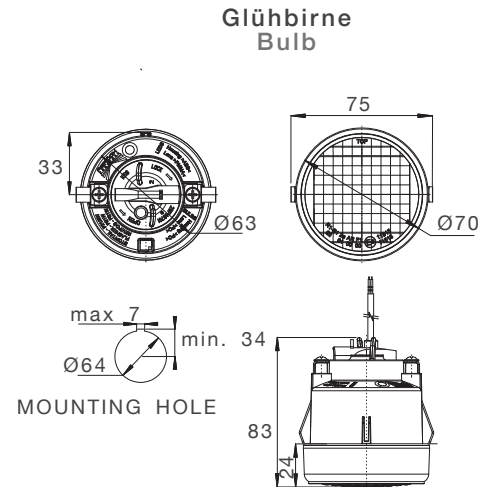
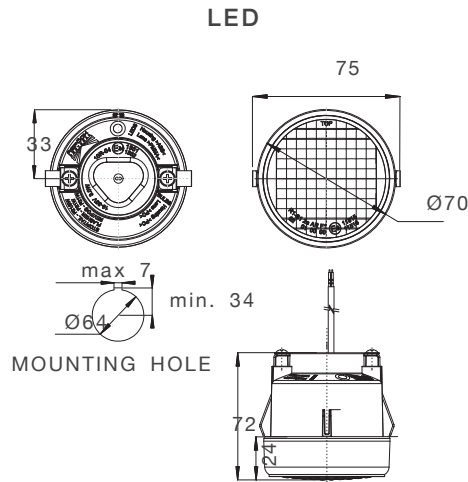

Maßeinheit / unit of measurement: mm

TECHNISCHE DATEN TECHNICAL FACTS		GLÜHBIRNE BULB	LED
SPANNUNGSBEREICH: VOLTAGE RANGE:		12V	12/24 V
ANSCHLUSS CONNECTOR:		1,8 m Kabel mit offenem Ende 1.8m open ended cable	1,8 m Kabel mit offenem Ende 1.8m open ended cable
MATERIAL: MATERIAL:	GEHÄUSE: HOUSING:	PC	ABS
	LICHTSCHEIBE LENS	PC	PMMA
TEMPERATURBEREICH: TEMPERATURE RANGE:		- 40°C~ +50°C	- 40°C~ +50°C
IP-KLASSE: IP-RATING:		IP54	IP6K9K
EMV-ABNAHME: EMC APPROVAL:		nicht notwendig not necessary	JA YES
LEISTUNG: POWER:	RÜCKLICHT: TAILLIGHT:	5 Watt	0,4 Watt
	BREMSLICHT: STOP LIGHT:	21 Watt	2,5 Watt
	BLINKER: DIRECTION INDICATOR:	21 Watt	2,4 Watt
	NEBELSCHLUSSLEUCHE: FOG LAMP:	21 Watt	1,5 Watt
	RÜCKFAHRLEUCHE: REVERSING LAMP:	21 Watt	1,9 Watt



BEST. NR PART NO	BEST. NR AM PART NO AM			V	FUNKTIONEN FUNCTIONS	VERSION	ANSCHLUSS CONNECTOR	KABEL CABLE
31-7600-007	1/100 31-7600-001	● ●		12V		[A]	offenes Ende open end	1,80 m
37-7600-007	1/100 37-7600-001	● ●		12V		[B]	offenes Ende open end	1,80 m
38-7600-007	1/100 38-7600-001	● ●		12V		[C]	offenes Ende open end	1,80 m
32-7600-007	1/100 32-7600-001	● ●		12V		[D]	offenes Ende open end	1,80 m
31-7600-707	1/90 31-7600-701	● ●		12V 24V		[A]	offenes Ende open end	1,70 m
37-7600-707	1/90 37-7600-701	● ●		12V 24V		[B]	offenes Ende open end	1,70 m
38-7600-707	1/90 38-7600-701	● ●		12V 24V		[C]	offenes Ende open end	1,70 m
32-7600-707	1/90 32-7600-701	● ●		12V 24V		[D]	offenes Ende open end	1,70 m























































ZUBEHÖR SPARE PARTS

BEST. NR OEM PART NO OEM		BESCHREIBUNG DESCRIPTION
15-5039-007		Adapterring für Roundpoint II Montage Adapter ring for mounting Roundpoint II



PIKTOGRAMM ÜBERSICHT PICTOGRAM OVERVIEW

	Verpackungseinheit packaging unit		Seitenmarkierungslicht + Reflektor sidemarker + reflector
	x Stück pro Karton x pieces per box		Positionslicht hinten rear position light
	links left		positionslicht vorne front position light
	rechts right		rot, weiß, orange red, white, amber
	Leuchtmittel light source		rot, weiß red, white
	Volt		rot red
	Umrissarm end outline marker		weiß white
	Glühbirne bulb		Umrissleuchte end outline marker
	LED		Rückstrahler rot reflector red
	Fahrrichtungsanzeiger direction indicator		Rückstrahler gelb reflector amber
	Fahrrichtungsanzeiger rechts direction indicator right		Rückstrahler weiß reflector white
	Fahrrichtungsanzeiger links direction indicator left		Arbeitsscheinwerfer working lamp
	dynamischer Fahrrichtungsanzeiger dynamic direction indicator		Kennzeichenbeleuchtung unten number plate lamp bottom
	dynamischer Fahrrichtungsanzeiger rechts dynamic direction indicator right		Kennzeichenbeleuchtung seitlich number plate lamp side
	dynamischer Fahrrichtungsanzeiger links dynamic direction indicator left		Rückfahralarm reverse alarm
	SMCG (Steuerung blinkender Seitenmarkierungsleuchten) SMCG (side marker control gear)		männlich male
	mit integriertem Blink-LCG with integrated direction indicator LCG		weiblich female
	mit integriertem LCG2 with integrated LCG2		Flood
	Rücklicht tail light		Spot
	Bremslicht stop light		horizontal Anbau horizontal mounting
	Nebelschlusslicht fog light		vertikal Anbau vertical mounting
	Rückfahrlicht reverse light		360° Anbau möglich 360° mounting possible
	Dreieckrückstrahler triangle reflector		... Lumen
	ohne Dreieckrückstrahler without triangle reflector		... Watt
	Positionslicht position light		ADR Zone 2
	Seitenmarkierungslicht sidemarker light		IP xx Schutzklasse IP xx rating
	Reflektor (Seitenmarkierungslicht) reflector (sidemarker light)		

product information_Roundpoint_II_V2 | 2024-07

Misprints, technical changes and illustrations are subject to change.

© Aspöck Systems GmbH

Non-compliance with the information given (e.g. temperature) results in the exclusion of warranty/liability. For details, see the mounting instructions/TSD www.aspoeck.com.