

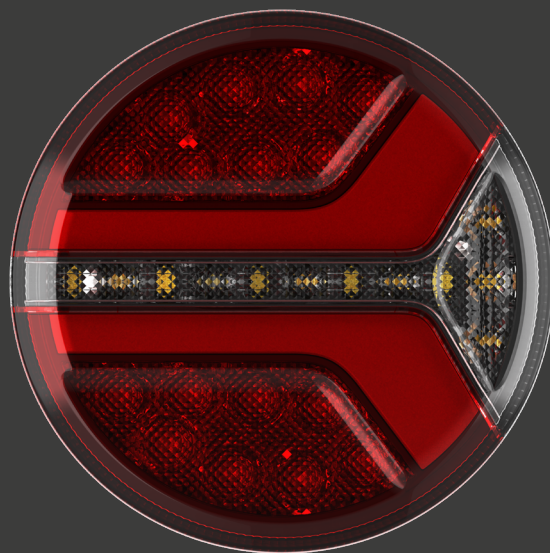

# ECOROUND

MONTAGEANLEITUNG

MOUNTING INSTRUCTION

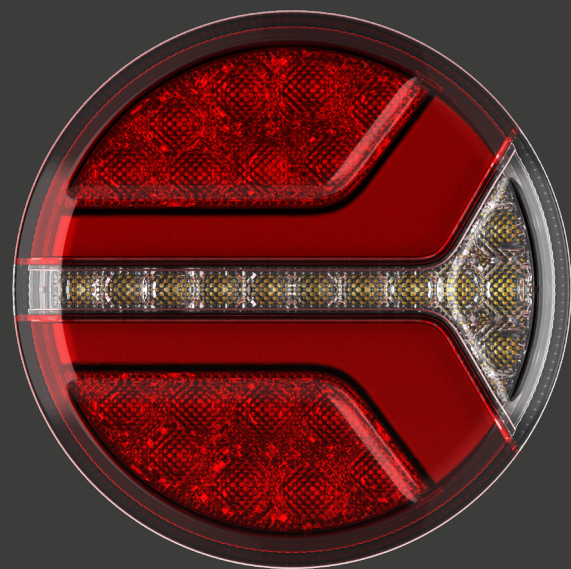

[aspoeck.com](http://aspoeck.com)



MOUNTING INSTRUCTION



## SERVICEHINWEISE SERVICE NOTES

- Vor Beginn der Montage die gesamte Montageanleitung sorgfältig durchlesen.
  - Diese Montageanleitung richtet sich an professionelle Aufbauhersteller und setzt entsprechendes Fachwissen voraus. Es ist zu beachten, dass bestimmte Arbeiten ausschließlich von qualifiziertem Personal ausgeführt werden dürfen, um Verletzungsrisiken zu minimieren und die erforderliche Qualität der Aufbauarbeiten sicherzustellen.
  - Im Rahmen von Produktverbesserungen behalten wir uns technische und optische Änderungen vor.
  - Bei Fragen oder Einbauproblemen den Aspöck-Kundendienst, einen Händler oder die Vertragswerkstatt kontaktieren.
  - Auf die ordnungsgemäße Trennung sowie die fachgerechte Entsorgung der Verpackungen, Hilfsmittel und Komponenten achten.
- 
- Read the entire mounting instructions carefully before starting assembly.
  - These mounting instructions are intended for professional vehicle body manufacturer and require appropriate expertise. Please note that certain work may only be carried out by qualified staff in order to minimise the risk of injury and to ensure the required quality of the assembly work.
  - We reserve the right to make technical and visual changes in the course of product improvements.
  - If you have any questions or installation problems, please contact Aspöck customer service, a dealer or the authorised workshop.
  - Ensure that packaging, auxiliary materials and components are properly separated and disposed of correctly.



## ALLGEMEIN GENERAL

Die ECOROUND ist eine Voll-Led-Mehrfunktionsleuchte, die an der hinteren Grenzkontur eines Anhängers, eines Kraftfahrzeuges oder im Agrarbereich zu finden und nach hinten gerichtet ist. Sie besteht aus 2 Leuchten mit unterschiedlichen Funktionen: Ein Leuchtenkörper mit den Funktionen: **Fahrtrichtungsanzeiger, Rückleuchte, Bremsleuchte**. Ein anderer Leuchtenkörper mit den Funktionen: **Nebelschlussleuchte, Rückfahrcheinwerfer**.

The ECOROUND is a full-LED multifunctional lamp that can be found on the rear contour of a trailer, a motor vehicle or in the agricultural sector, facing backwards. It consists of two lamps with different functions: one lamp body with the functions: **directional indicator, tail lamp, brake light**. Another lamp body with the functions: **rear fog lamp, reversing light**.

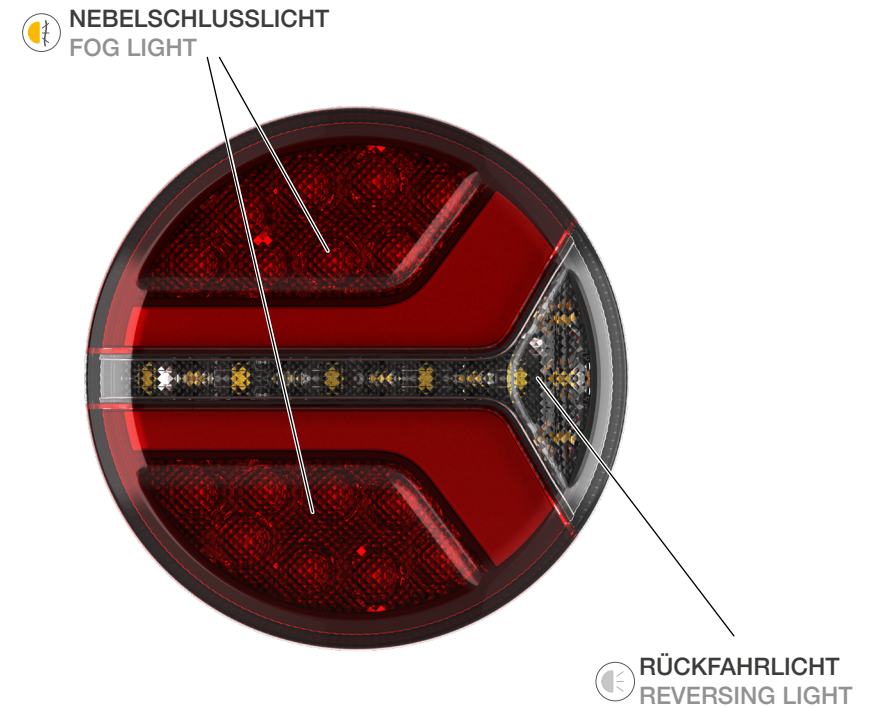
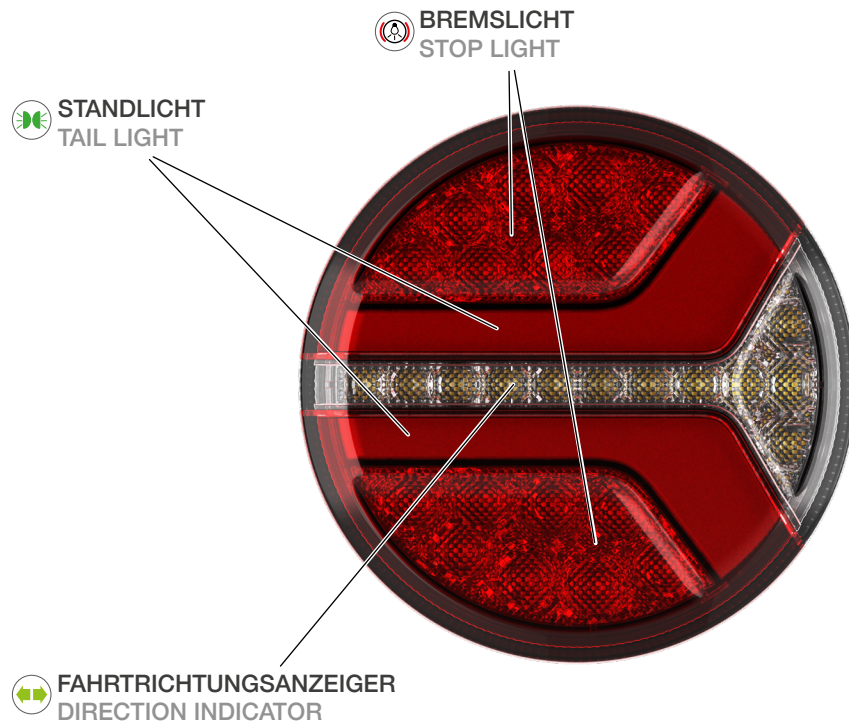



## SYMBOLERKLÄRUNG EXPLANATION SYMBOLS



RICHTIG  
CORRECT



FALSCH  
INCORRECT



POSITIONSPFEIL  
POSITION ARROW



BEWEGUNGSPFEIL  
MOVEMENT ARROW



ACHTUNG  
WARNING



SEHEN - KONTROLLIEREN  
LOOK - CONTROL

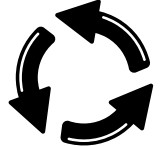

DREHEN  
TWIST

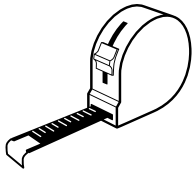

MESSEN  
MEASURE

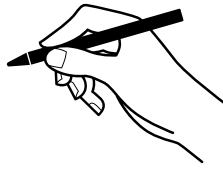

MARKIEREN  
MARK



ANKÖRNEN  
CENTRE PUNCH

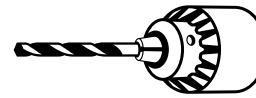

BOHREN KLEIN  
DRILL SMALL

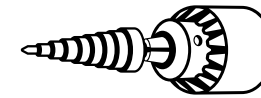

BOHREN GROSS  
DRILL BIG



KORROSIONSSCHUTZ  
CORROSION PROTECTION



ENTSORGEN  
RECYCLE



SÄUBERN  
CLEAN

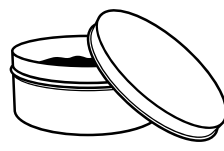

KONTAKTFETT  
CONTACT GREASE

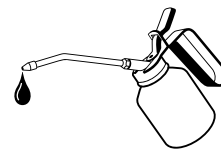

ÖLEN  
OILING

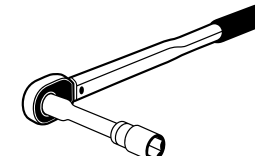

DREHMOMENTSCHLÜSSEL  
TORQUE WRENCH

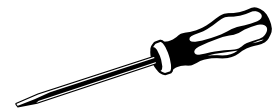

SCHRAUBENDREHER  
SCREWDRIVER



## ANBAUMASSE (ECE 48) PLACERING

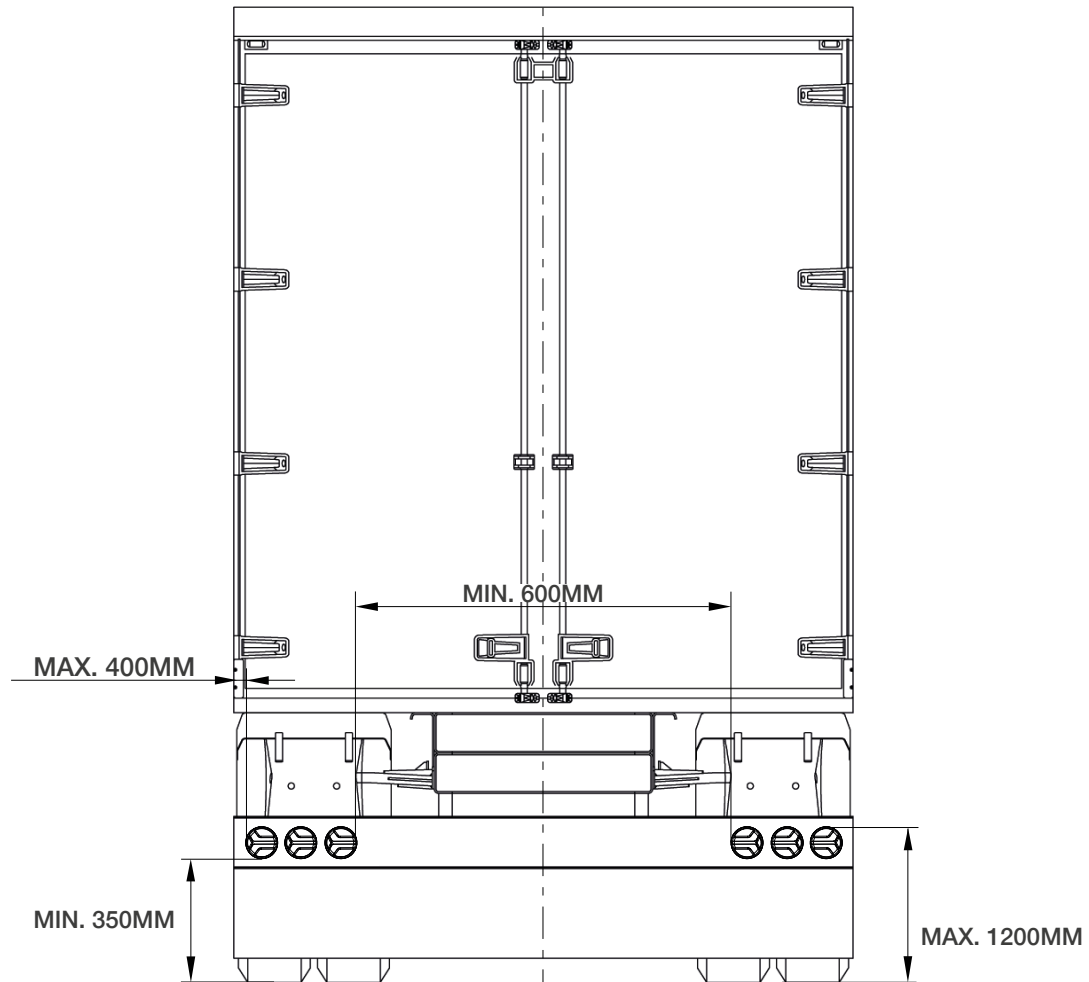



## BOHRBILD HOLE PATTERN

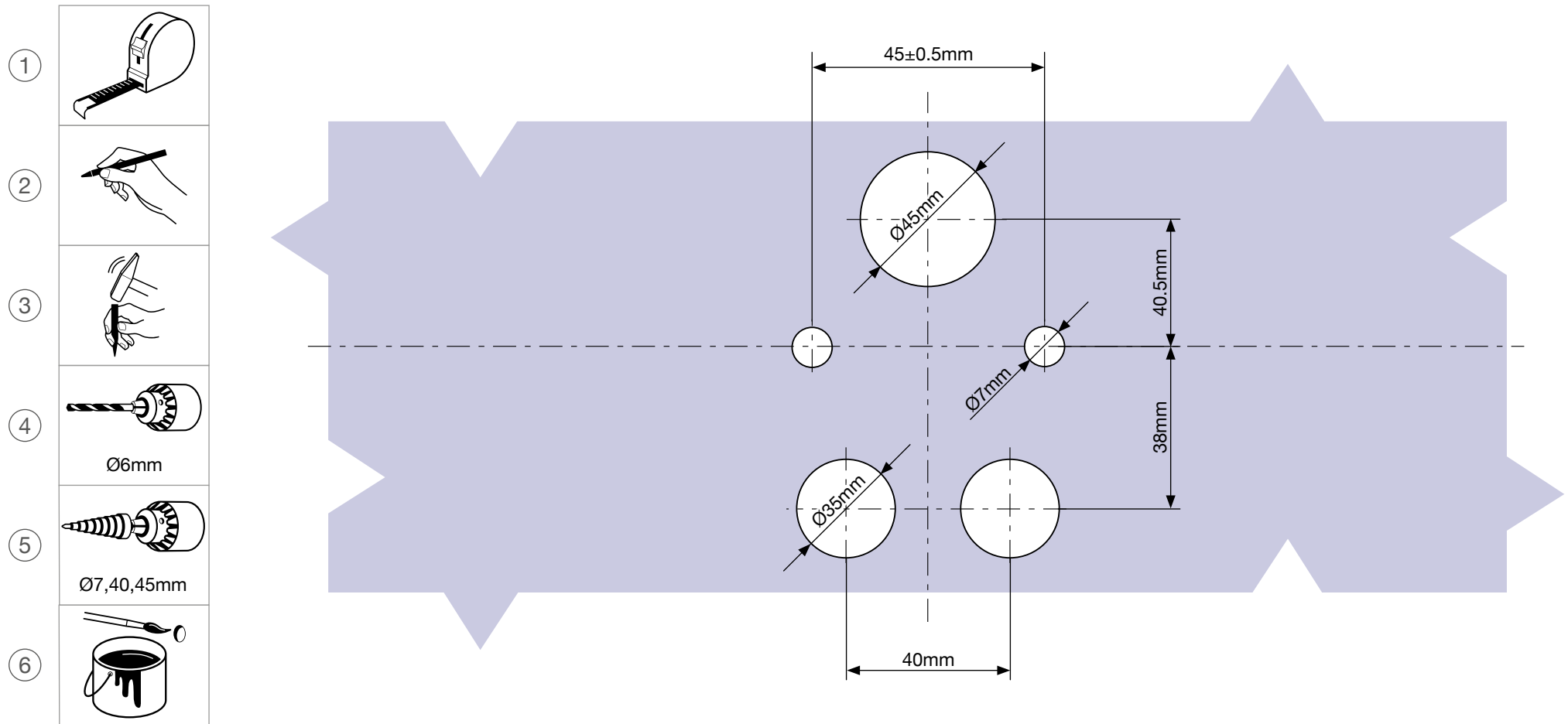



## MONTAGE MOUNTING

①, ②

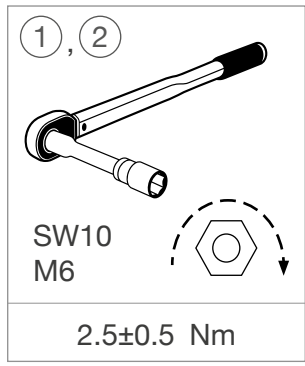

SW10  
M6

$2.5 \pm 0.5 \text{ Nm}$

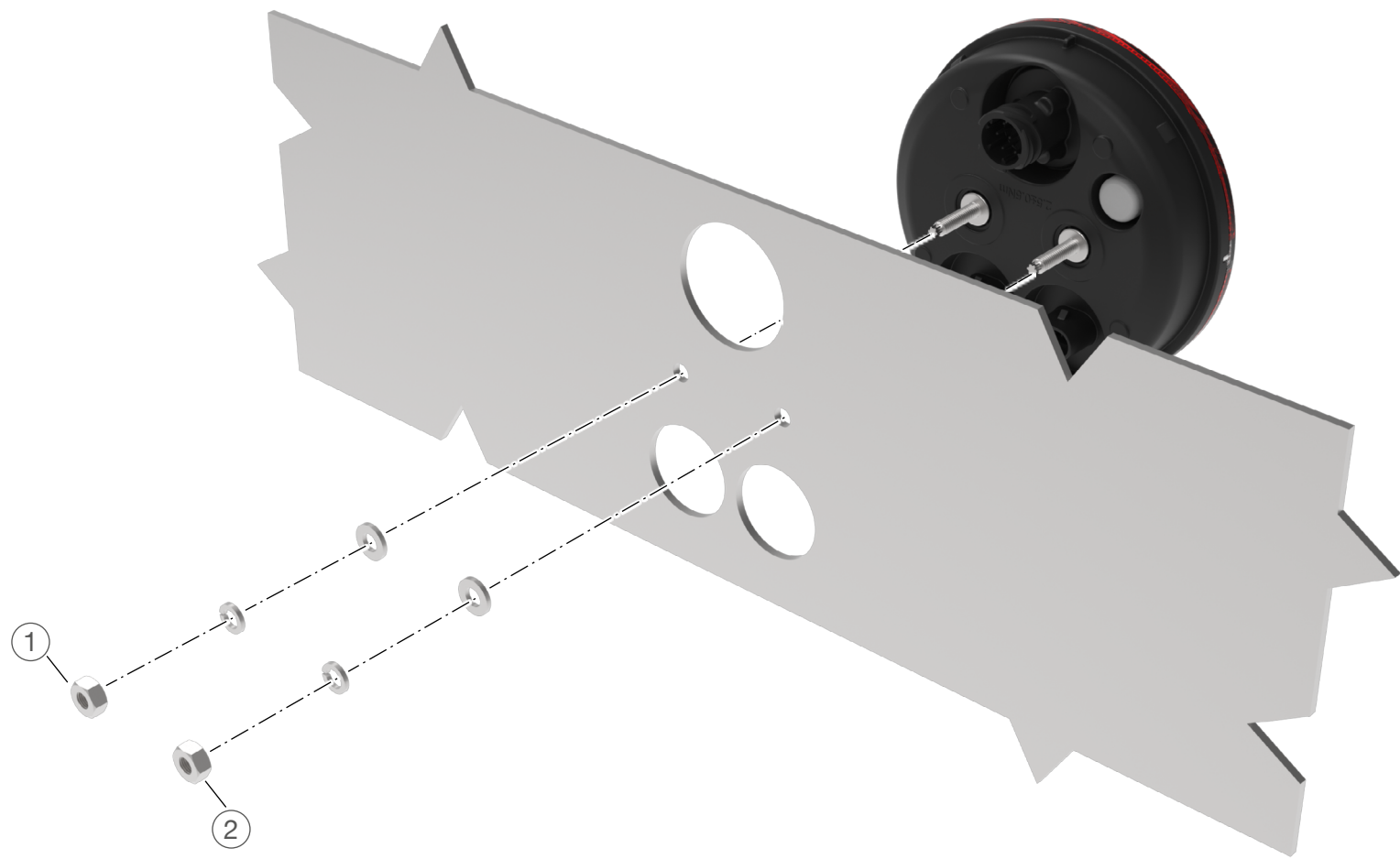



## VERSIONSUNTERSCHIED VERSION DIFFERENCE

Standlicht, Fahrtrichtungsanzeiger, Bremslicht  
tail light, directional indicator, stop light

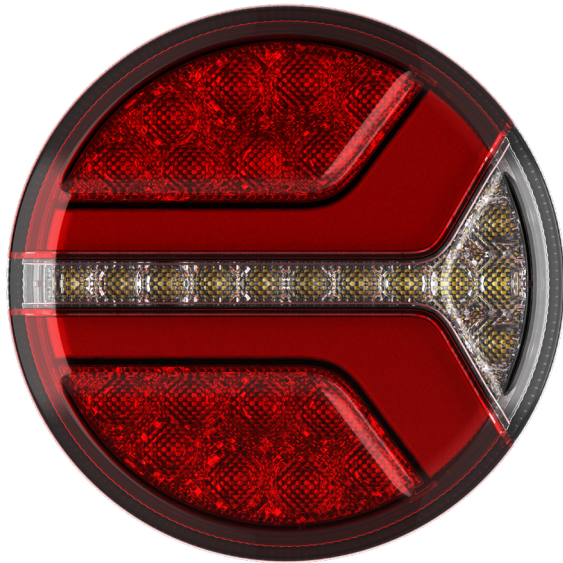
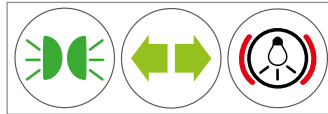

Nebelschlusslicht, Rückfahrlicht  
reverse light, fog light

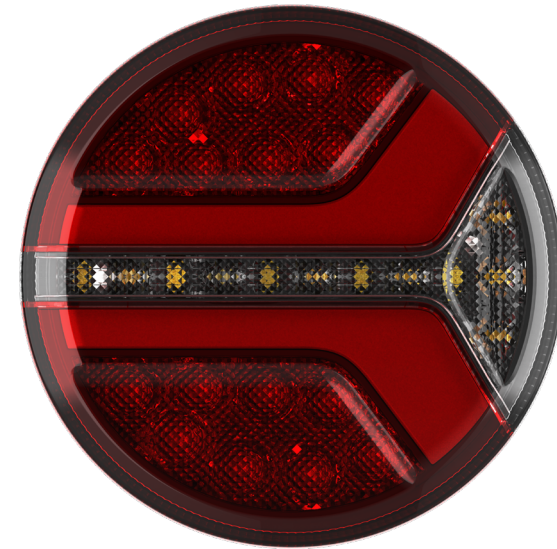
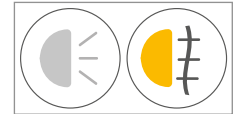







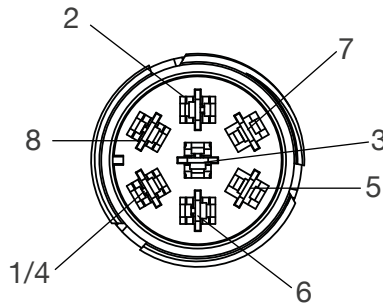
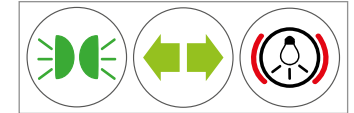



## ANSCHLÜSSE ASS2 7 POL MIT KABEL + ASS2 CONNECTORS ASS2 7 PIN WITH CABLE + ASS2



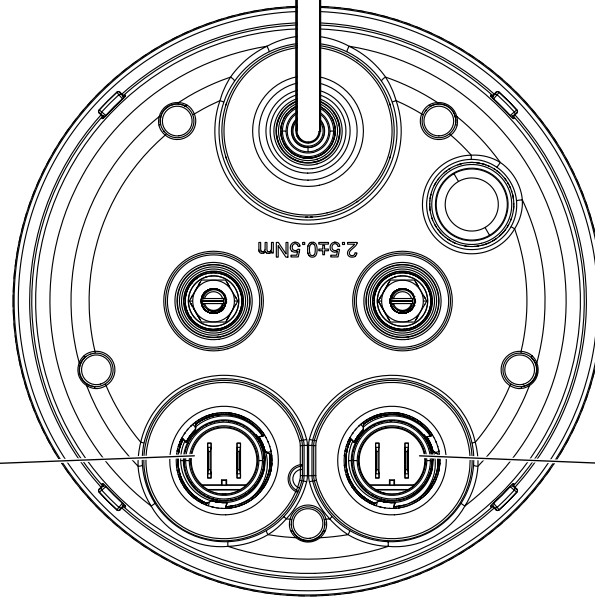

1	2	3	4	5	6	7
GND	-	DI	Stop	-	Tail	-
	-			-		-

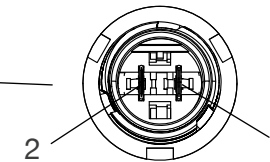
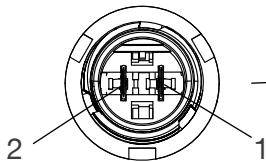

1	GND	
2	Tail (SMCG)	
max. 1A		







1	GND	
2	Tail	
max. 5A		

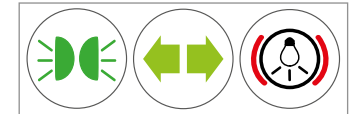



## ANSCHLÜSSE DIN + ASS2 CONNECTORS DIN + ASS2



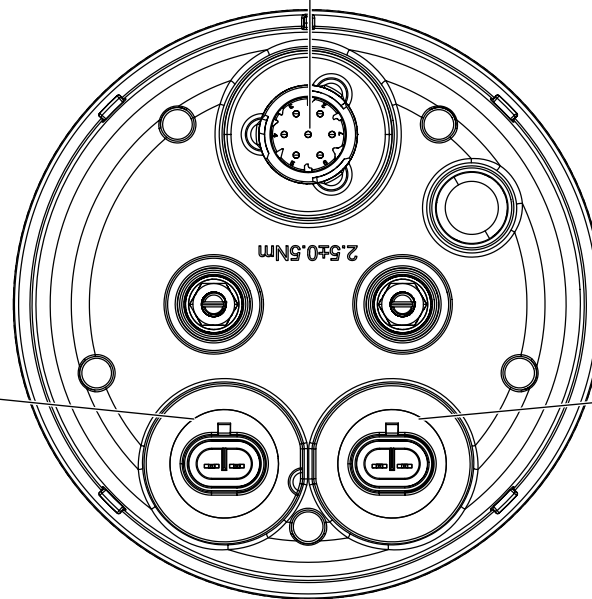
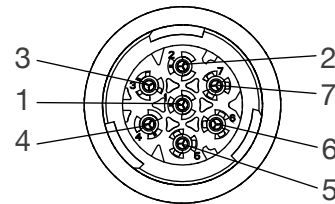

1	2	3	4	5	6	7
GND	Tail	-	DI	Stop	-	-
		-			-	-

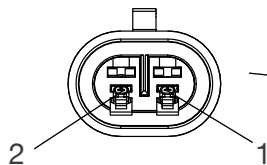

1	GND	
2	Tail (SMCG)	
max. 1A		



1	GND	
2	Tail	
max. 5A		

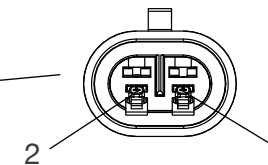



## ANSCHLÜSSE DIN CONNECTORS DIN

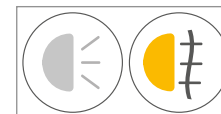

1	2	3	4	5	6	7
GND	-	-	-	Reverse	Fog	-
	-	-	-			-

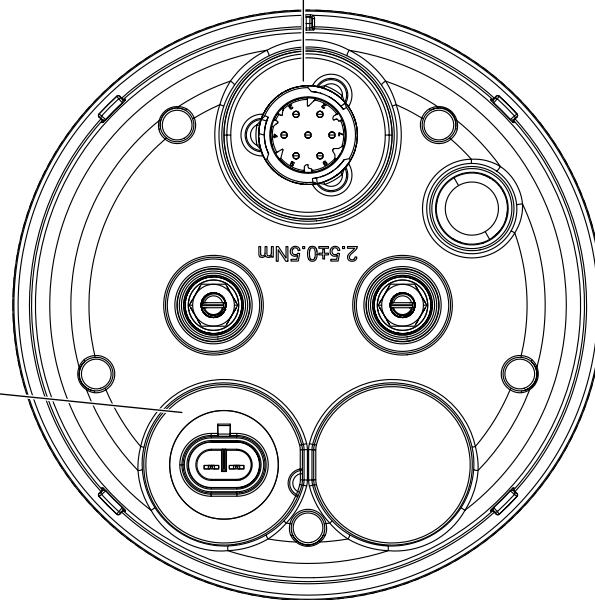
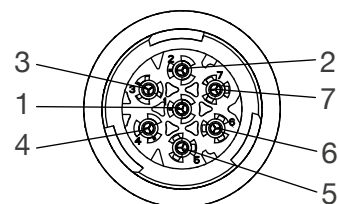



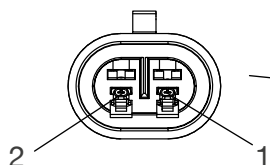

1	GND	
2	Reverse	
max. 5A		



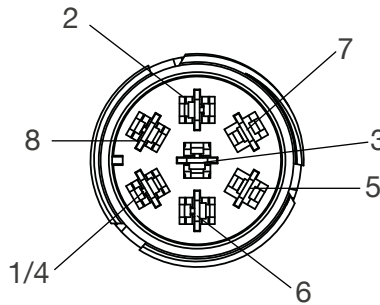
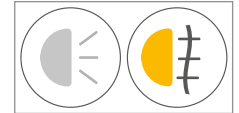

## ANSCHLÜSSE ASS2 7 POL MIT KABEL + ASS2 CONNECTORS ASS2 7 PIN WITH CABLE + ASS2



1	2	3	4	5	6	7
GND	-	-	-	Reverse	-	Fog
	-	-	-		-	

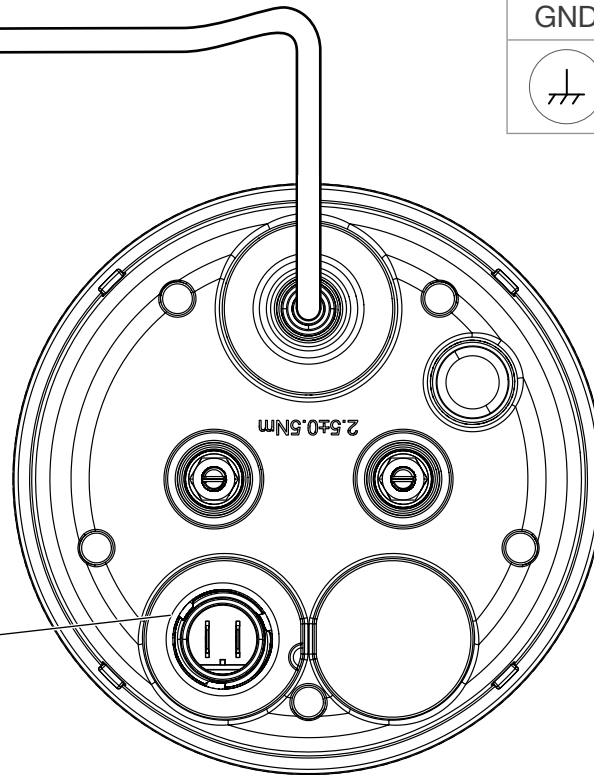

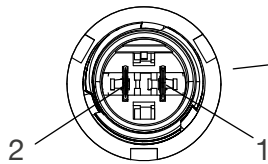

1	GND	
2	Reverse	
max. 5A		



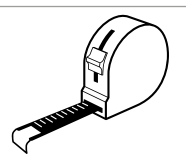
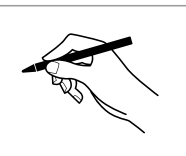
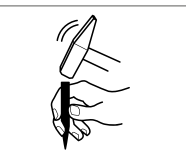
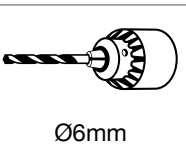
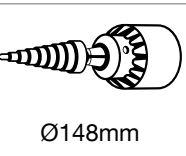

## BOHRBILD CHROM-RING HOLE PATTERN CHROME RING

- ① 
- ② 
- ③ 
- ④   
Ø6mm
- ⑤   
Ø148mm
- ⑥ 

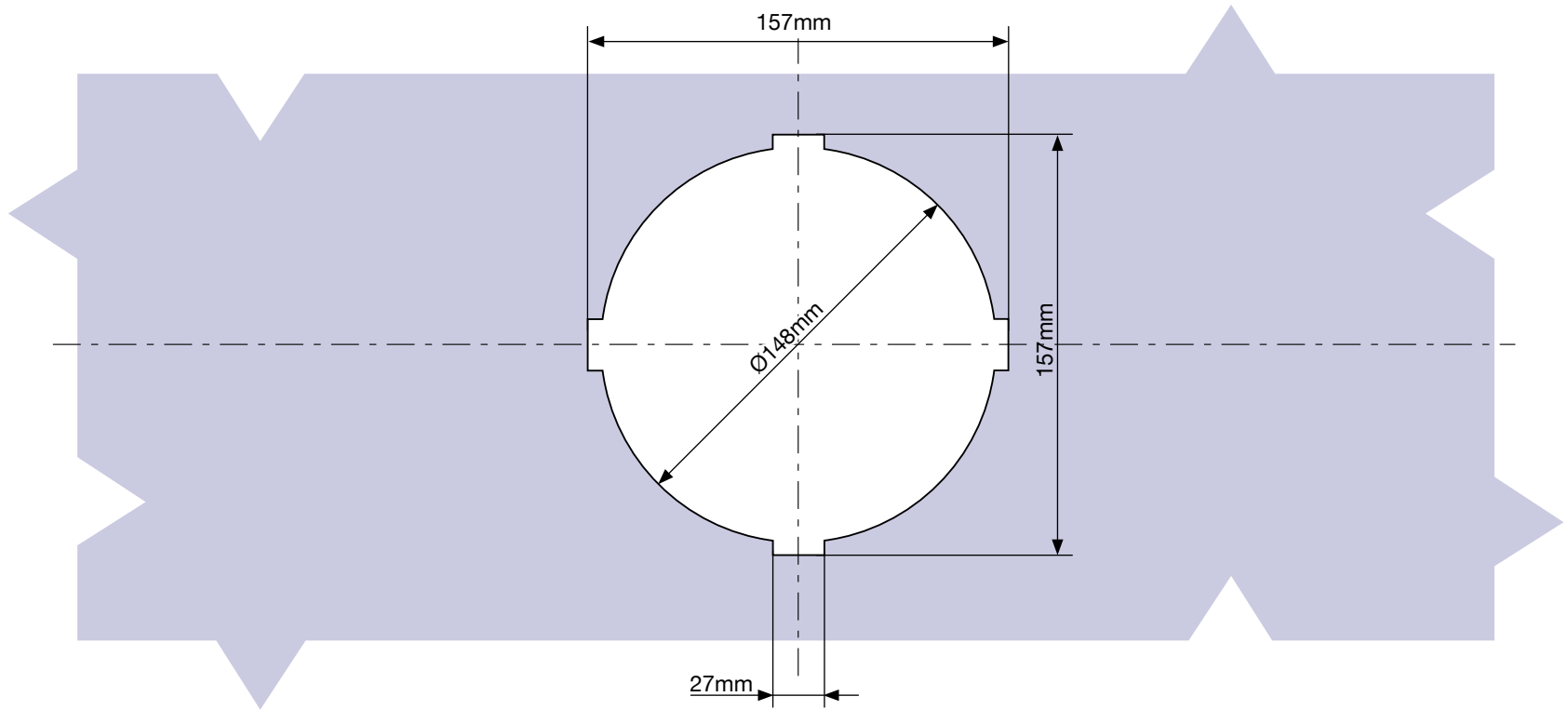



## MONTAGE CHROM-RING MONTAGE CHROME RING

①, ②

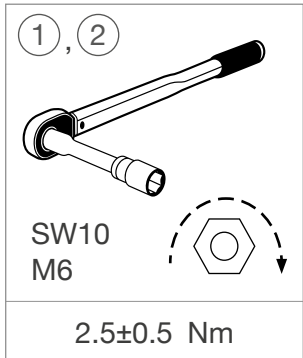

SW10  
M6

2.5±0.5 Nm

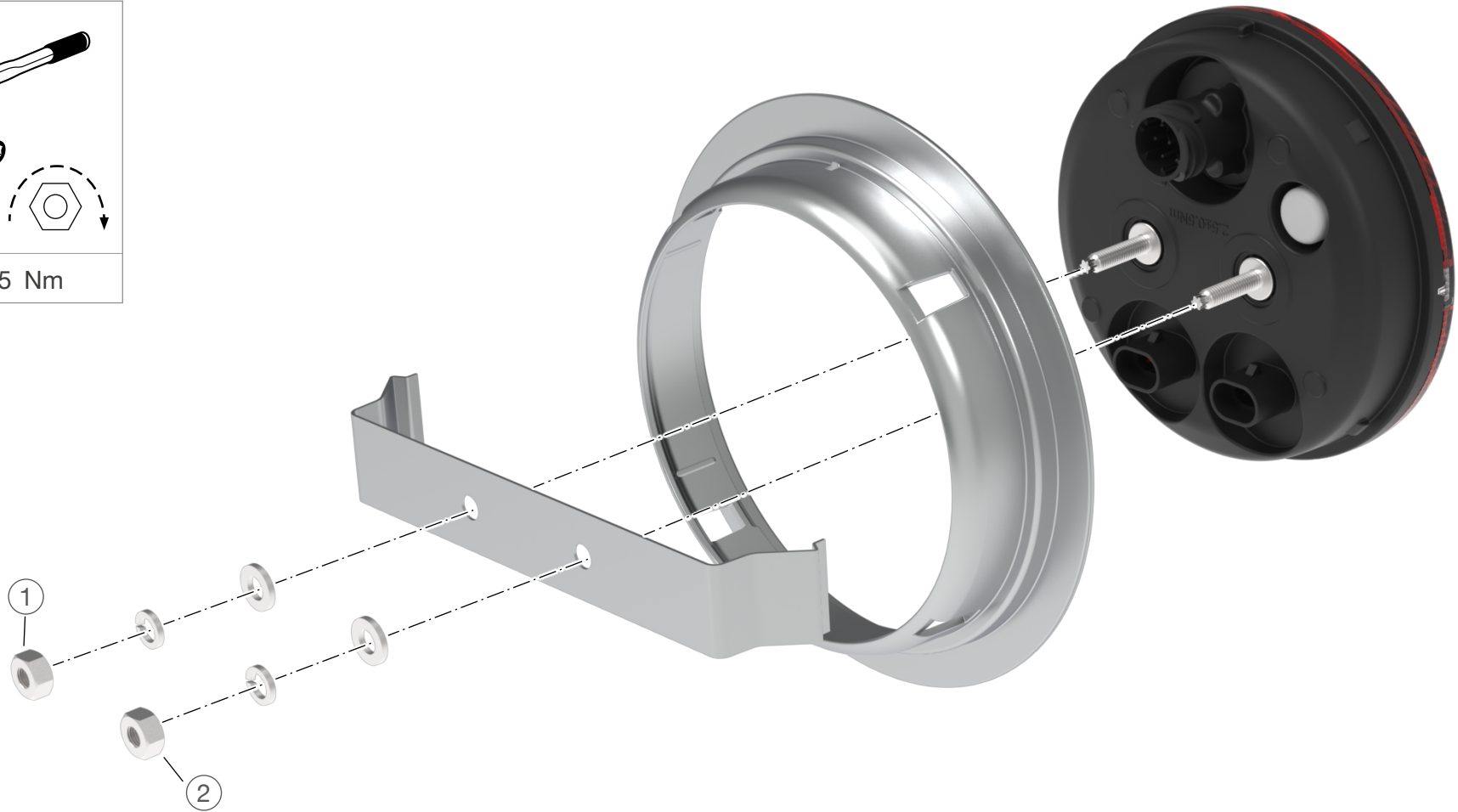



## MONTAGE CHROM-RING MONTAGE CHROME RING

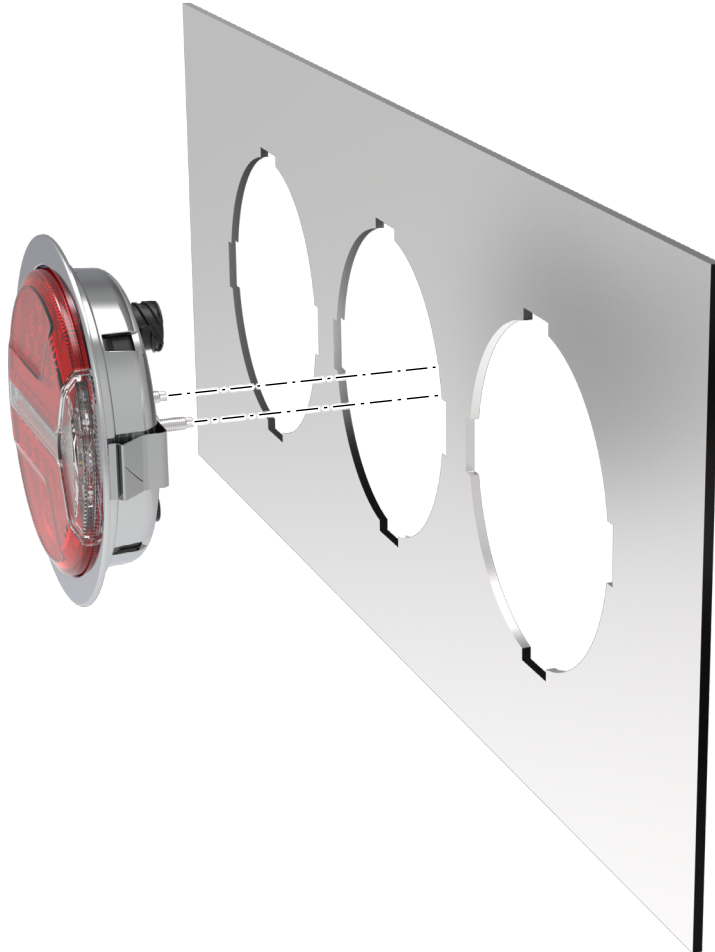



## ANBAUMÖGLICHKEITEN HORIZONTAL MOUNTING OPTIONS HORIZONTAL

①



②



③







## ANBAUMÖGLICHKEITEN HORIZONTAL MOUNTING OPTIONS HORIZONTAL

④



⑤



⑥





## ANBAUMÖGLICHKEITEN HORIZONTAL BEISPIEL MOUNTING OPTIONS HORIZONTAL EXAMPLE

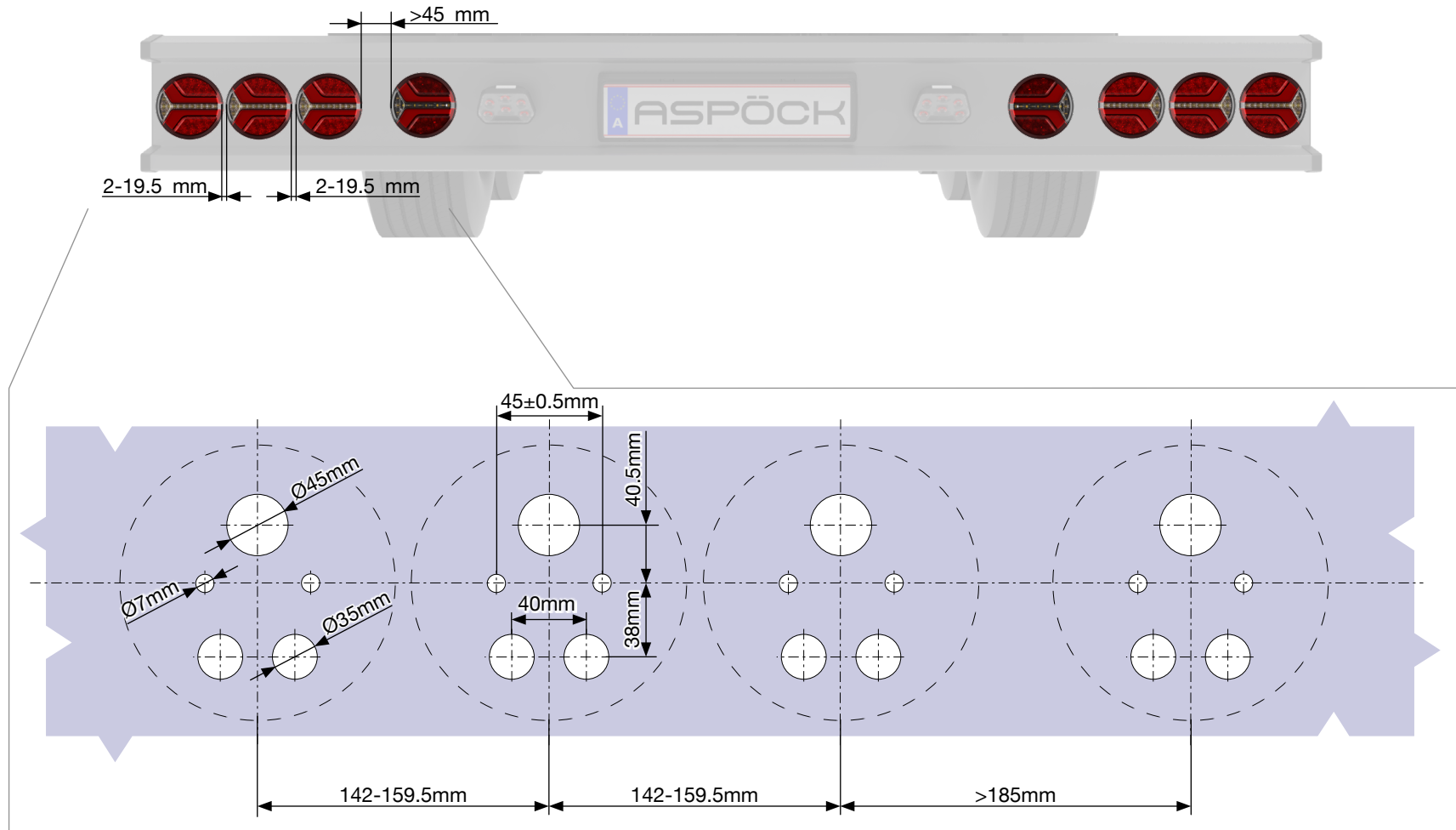



## ANBAUMÖGLICHKEITEN VERTIKAL MOUNTING OPTIONS VERTICAL

7



8





## ANBAUMÖGLICHKEITEN VERTIKAL MOUNTING OPTIONS VERTICAL

9



10





## PFLEGEANLEITUNG CARE INSTRUCTION

### Lichtscheibe:

- Abspülen unter fließendem Wasser
- Bei Bedarf ein wenig Spülmittel (kein Scheuermittel!) verwenden
- Mit einem weichem Tuch oder Schwamm säubern und anschließend trocknen
- Kein Mikrofaser Tuch oder Scheuerschwamm verwenden

### Lens:

- Rinse under running water
- Use a little detergent if necessary (not a scouring agent!)
- Clean with a soft cloth or sponge and then dry
- Do not use a microfibre cloth or scouring pad!

Beleuchtungsanlage auf einwandfreie Funktion hin prüfen.

Bei Fragen oder Einbauproblemen den Aspöck-Kundendienst, einen Händler oder die Vertragswerkstatt kontaktieren.

Check that the lighting system is working perfectly.

If you have any questions or installation problems, please contact Aspöck customer service, a dealer or the authorised workshop.



## HAFTUNGSBESTIMMUNGEN LIABILITY PROVISIONS

### Allgemeines:

- Nationale Anbau-, Einbau- und Betriebsvorschriften sind einzuhalten.
- Eine Verwendung darf ausschließlich gemäß beigelegten Anleitungen und Sicherheitshinweisen erfolgen. Anleitungen sind online auf der Website unter [www.aspoeck.com](http://www.aspoeck.com) zu finden.
- Änderungen am Produkt dürfen nicht vorgenommen werden, es sei denn es werden ausschließlich die hierfür vorgesehenen Original-Ersatzteile oder von Aspöck freigegebene Ersatzteile verwendet und von fachlich qualifiziertem Personal eingebaut.

### Gewährleistungsausschluss:

- Bei Nichtbeachtung der in dieser Montageanleitung sowie der in dem Produktdatenblatt, angegebenen Hinweise und Informationen, bei nicht bestimmungsgemäßem Gebrauch, bei Einsatz außerhalb des vorgesehenen Verwendungszweckes bzw. außerhalb der vorgesehenen Einsatzbedingungen, ist die Gewährleistung für sämtliche Schäden am Produkt ausgeschlossen.
- Die Gewährleistung erstreckt sich weiters nicht auf Produkte, welche aufgrund von Gefahren (einschließlich Umweltgefahren, Gefahren im Straßenverkehr oder durch Dritte verursachte Gefahren oder Umstände, die außerhalb der Kontrolle von Aspöck liegen) beschädigt wurden oder sich in einem schlechten Betriebszustand befinden.
- Die Reparatur oder der Austausch eines mangelhaften Produktes löst nicht den Beginn einer neuen Gewährleistungsfrist aus.
- Weitere Gewährleistungsbestimmungen sind im Punkt 10 der Verkaufs- und Lieferbedingungen (VLB) [www.aspoeck.com](http://www.aspoeck.com) zu finden.

### Haftungsausschluss:

- Aspöck Systems übernimmt keine Haftung für mittelbare Schäden, Folgeschäden und Vermögensschäden.
- Weitere (limitierende) Haftungsbestimmungen sind im Punkt 11 der Verkaufs-, und Lieferbedingungen (VLB) [www.aspoeck.com](http://www.aspoeck.com) zu finden.
- Limitierende Bestimmungen zur Produkthaftung sind im Punkt 12 der Verkaufs-, und Lieferbedingungen statuiert (VLB) [www.aspoeck.com](http://www.aspoeck.com).

### General information:

- National mounting, installation and operating regulations must be observed.
- The product may only be used in accordance with the enclosed instructions and safety notes. Instructions can be found online at [www.aspoeck.com](http://www.aspoeck.com).
- No modifications may be made to the product unless only the original spare parts intended for this purpose or spare parts approved by Aspöck are used and installed by professionally qualified personnel.

### Exclusion of warranty:

- Warranty for any product damage is excluded in the event of non-compliance with the instructions and information given in these installation instructions and in the product data sheet, in the event of use outside of that intended, outside the intended purpose or outside the intended operating conditions.
- The warranty also does not cover products that have been damaged or are in poor operating condition due to hazards (including environmental hazards, road traffic hazards, hazards caused by third parties or circumstances beyond the control of Aspöck).
- Repair or replacement of a defective product does not result in the start of a new warranty period.
- Other warranty provisions can be found in item 10 of the Terms of Sales and Delivery (TSD) [www.aspoeck.com](http://www.aspoeck.com).

### Exclusion of liability:

- Aspöck Systems accepts no liability for indirect damage, consequential damage and financial losses.
- Other (limiting) liability provisions can be found in item 11 of the Terms of Sales and Delivery (TSD) [www.aspoeck.com](http://www.aspoeck.com).
- Limiting product liability provisions are laid down in item 12 of the Terms of Sales and Delivery (TSD) [www.aspoeck.com](http://www.aspoeck.com).



# THE ART OF LIGHTS

**ASPÖCK Systems GmbH**

Enzing 4, 4722 Peuerbach, AUSTRIA

Office: +43 7276 2670-0

E-Mail: office@aspoeck.com



**aspoeck.com**

