



MOUNTING INSTRUCTION

ECOLED II Smartbox

MONTAGEANLEITUNG

MOUNTING INSTRUCTION



aspoeck.com





SERVICEHINWEISE SERVICE NOTES

- Vor Beginn der Montage die gesamte Montageanleitung sorgfältig durchlesen.
 - Diese Montageanleitung richtet sich an professionelle Aufbauhersteller und setzt entsprechendes Fachwissen voraus. Es ist zu beachten, dass bestimmte Arbeiten ausschließlich von qualifiziertem Personal ausgeführt werden dürfen, um Verletzungsrisiken zu minimieren und die erforderliche Qualität der Aufbauarbeiten sicherzustellen.
 - Im Rahmen von Produktverbesserungen behalten wir uns technische und optische Änderungen vor.
 - Bei Fragen oder Einbauproblemen den Aspöck-Kundendienst, einen Händler oder die Vertragswerkstatt kontaktieren.
 - Auf die ordnungsgemäße Trennung sowie die fachgerechte Entsorgung der Verpackungen, Hilfsmittel und Komponenten achten.
-
- Read the entire mounting instructions carefully before starting assembly.
 - These mounting instructions are intended for professional vehicle body manufacturer and require appropriate expertise. Please note that certain work may only be carried out by qualified staff in order to minimise the risk of injury and to ensure the required quality of the assembly work.
 - We reserve the right to make technical and visual changes in the course of product improvements.
 - If you have any questions or installation problems, please contact Aspöck customer service, a dealer or the authorised workshop.
 - Ensure that packaging, auxiliary materials and components are properly separated and disposed of correctly.



ALLGEMEIN GENERAL

Die Smartbox beinhaltet eine ECOLED II, welche individuell für den linken und rechten Anbau am Fahrzeug zusammengebaut werden kann. Die Leuchte selbst ist eine Voll-Led-Mehrfunktionsleuchte, die an der hinteren Grenzkontur eines Kraftfahrzeuges oder Anhängers zu finden und nach hinten gerichtet ist. Sie besteht aus folgenden Einzelfunktionen, die in einem Leuchtenkörper kombiniert sind: **Fahrtrichtungsanzeiger, Rückleuchte, Schlussleuchte, Bremsleuchte, Nebelschlussleuchte, Rückfahrscheinwerfer, Retroreflexion und optional Umrissleuchten.**

The Smartbox contains an ECOLED II, which can be individually assembled for left and right mounting on the vehicle. The lamp itself is a Full-LED multi-function lamp that is located at the rear of a vehicle or trailer and is directed to the rear. It consists of the following individual functions, which are combined in one light unit: **Direction indicator, Rear position lamp, Stop lamp, Rear fog lamp, Reversing lamp, Retroreflection and optional End-outline marker lamp.**

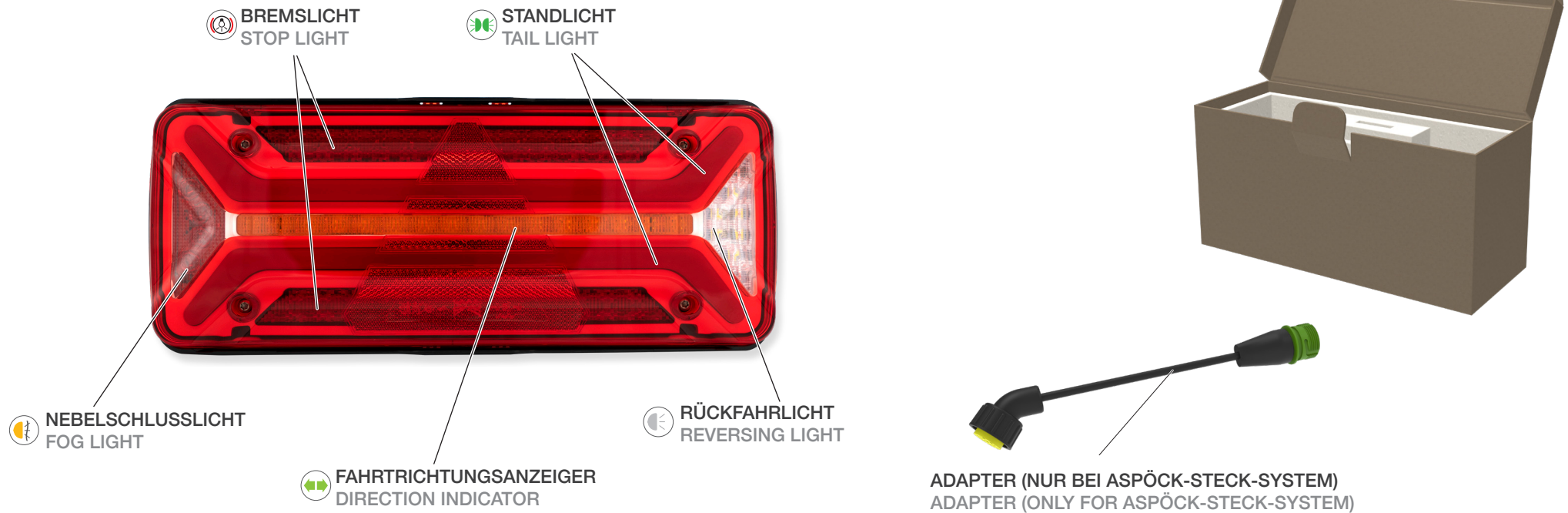



SYMBOLERKLÄRUNG EXPLANATION SYMBOLS



RICHTIG
CORRECT



FALSCH
INCORRECT



POSITIONSPFEIL
POSITION ARROW



BEWEGUNGSPFEIL
MOVEMENT ARROW



ACHTUNG
WARNING



SEHEN - KONTROLLIEREN
LOOK - CONTROL



DREHEN
TWIST

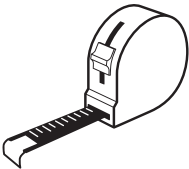

MESSEN
MEASURE

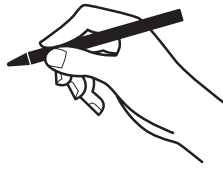

MARKIEREN
MARK



ANKÖRNEN
CENTRE PUNCH

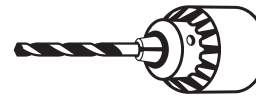

BOHREN KLEIN
DRILL SMALL



BOHREN GROSS
DRILL BIG



KORROSIONSSCHUTZ
CORROSION PROTECTION



ENTSORGEN
RECYCLE



SÄUBERN
CLEAN

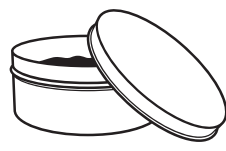

KONTAKTFETT
CONTACT GREASE

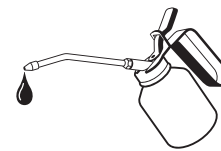

ÖLEN
OILING

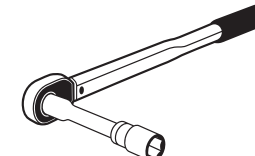

DREHMOMENTSCHLÜSSEL
TORQUE WRENCH



SCHRAUBENDREHER
SCREWDRIVER



SCHUTZFOLIE ENTFERNEN REMOVE PROTECTIVE FILM

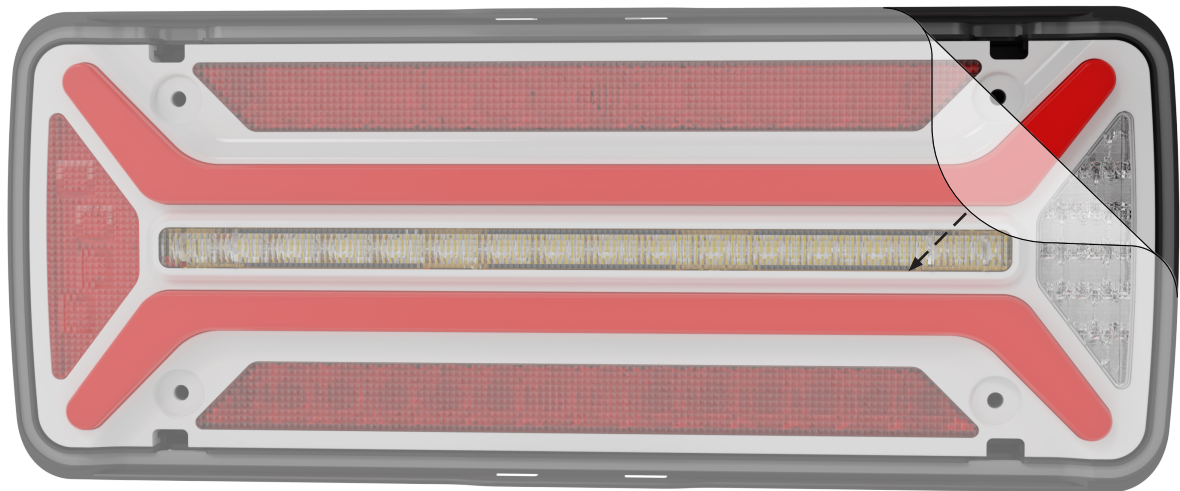
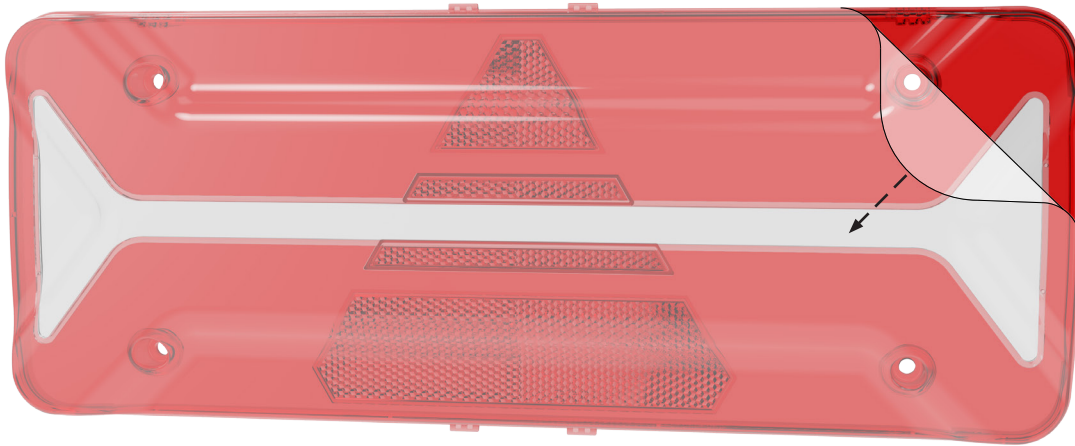



MONTAGEVORBEREITUNGEN MOUNTING PREPARATIONS

- 1. Dichtung kontrollieren:
1. check seal:

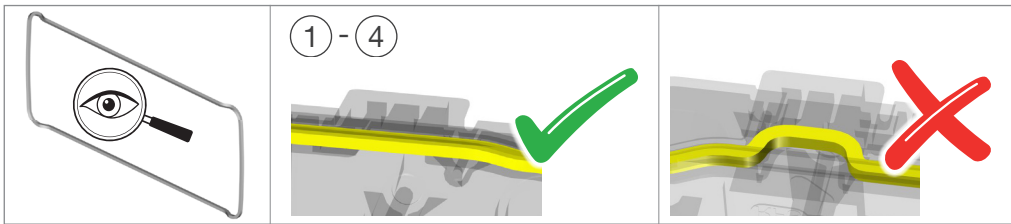

- 2. Positionsbestimmung:
2. positioning:

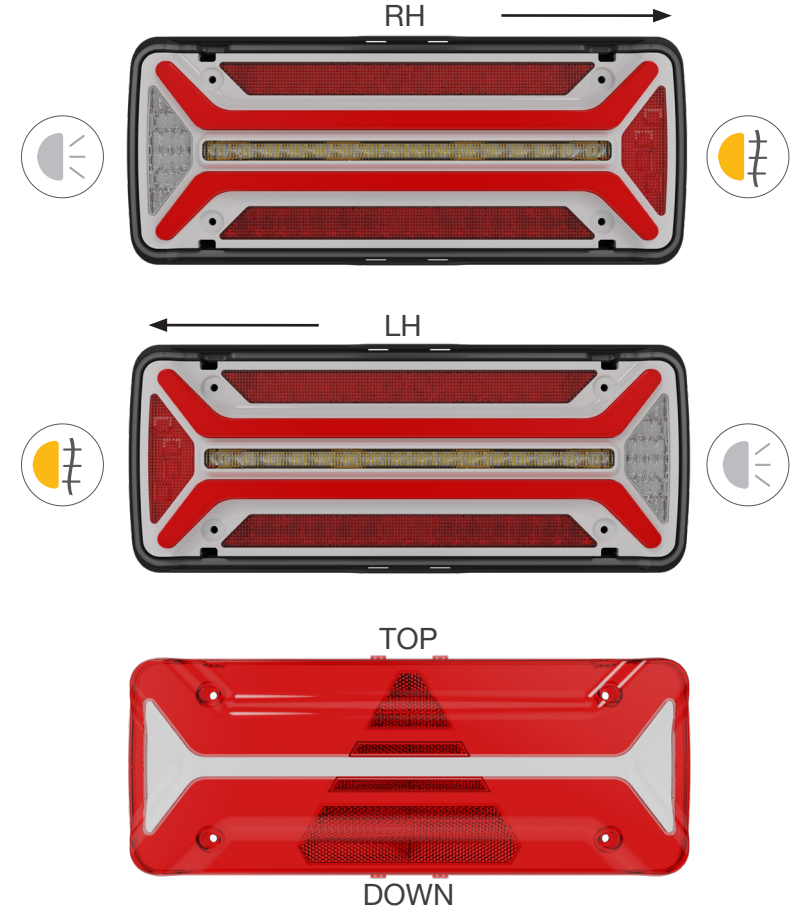



LICHTSCHEIBE MONTIEREN MOUNTING THE LENS

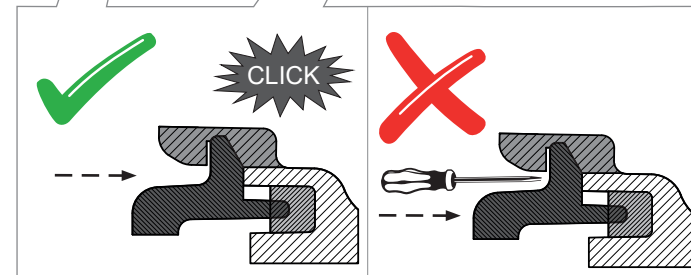





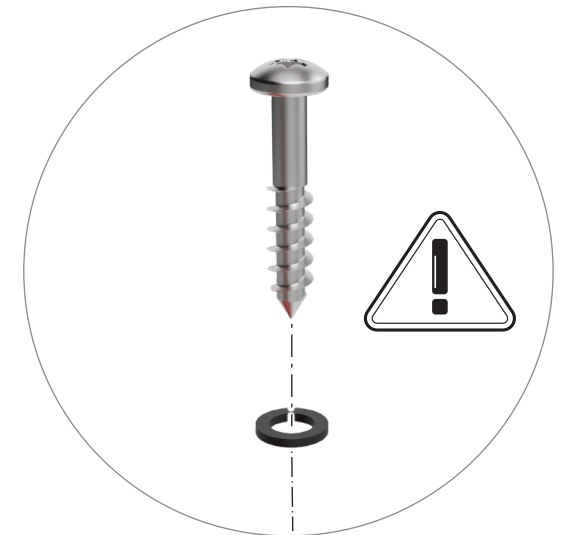
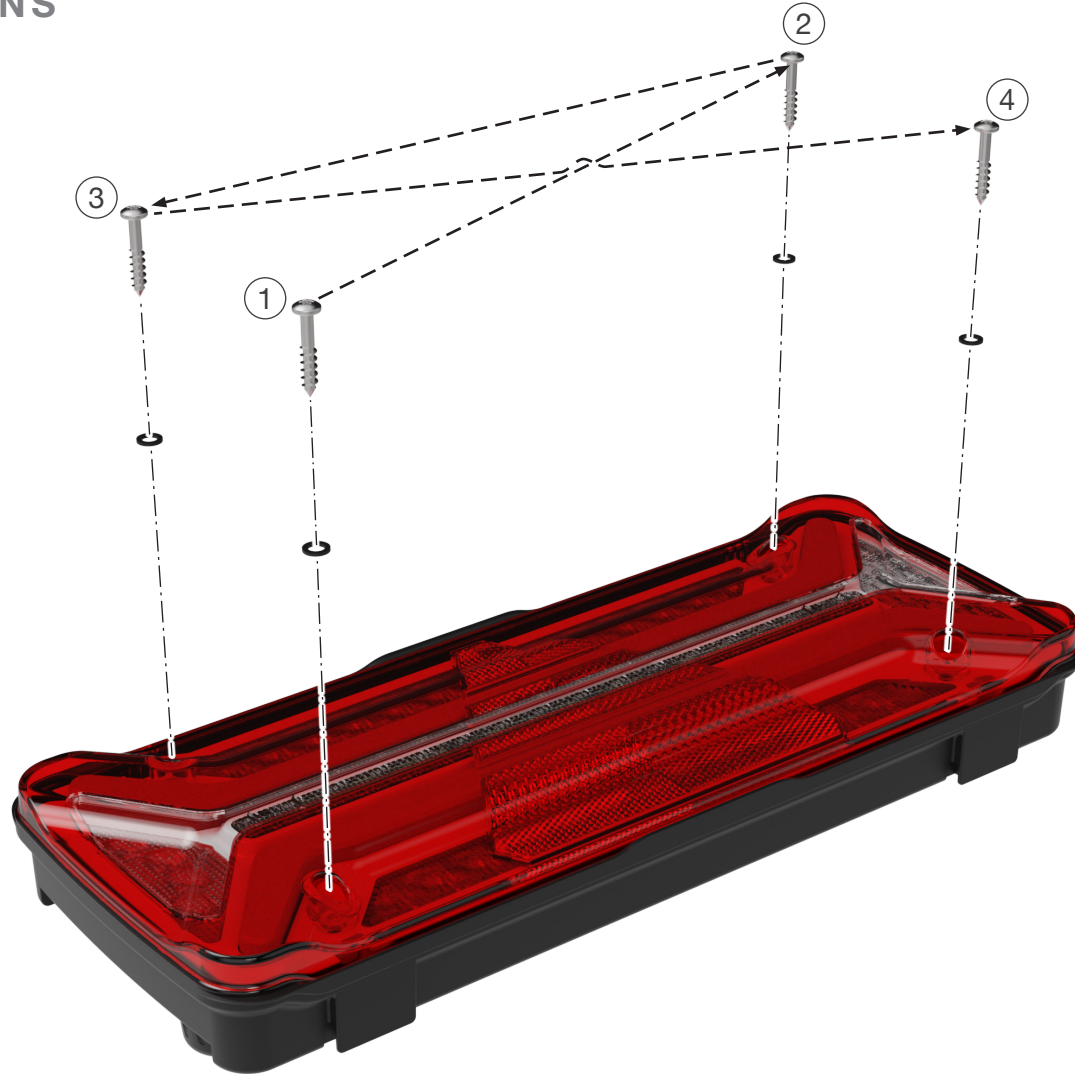
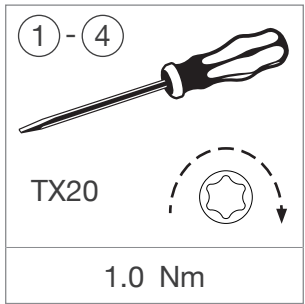

LICHTSCHEIBE VERSCHRAUBEN SCREWING THE LENS



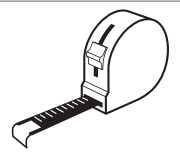

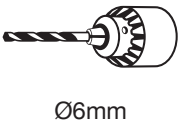
BOHRBILD HOLE PATTERN

- ① 
- ② 
- ③ 
- ④ 
Ø6mm
- ⑤ 
Ø9,10,30,42mm
- ⑥ 

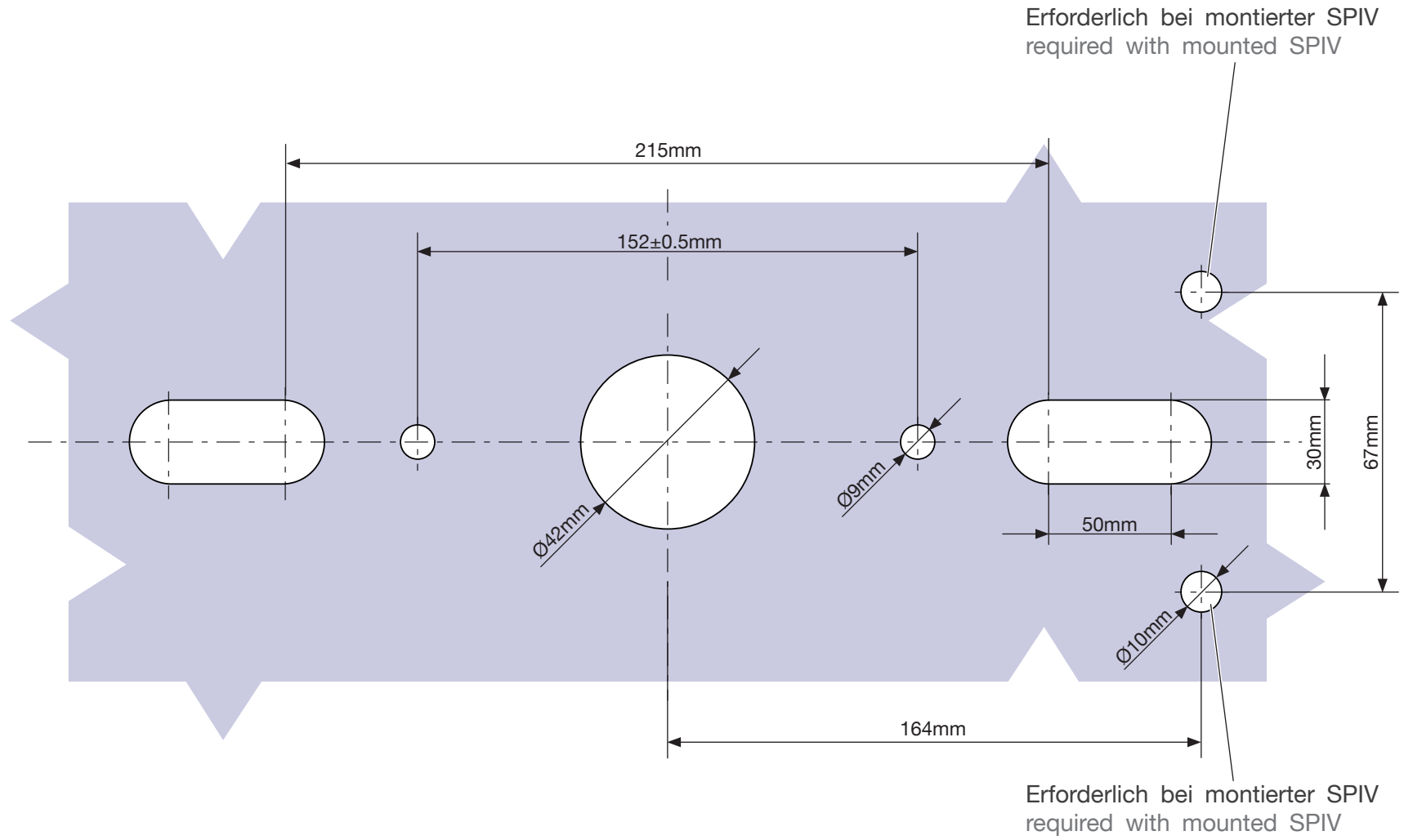



MONTAGE MOUNTING

①, ②

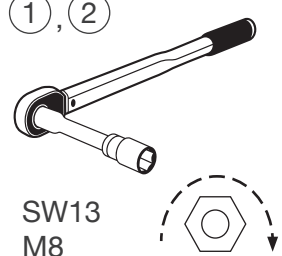

SW13
M8

5.5 - 6.0 Nm

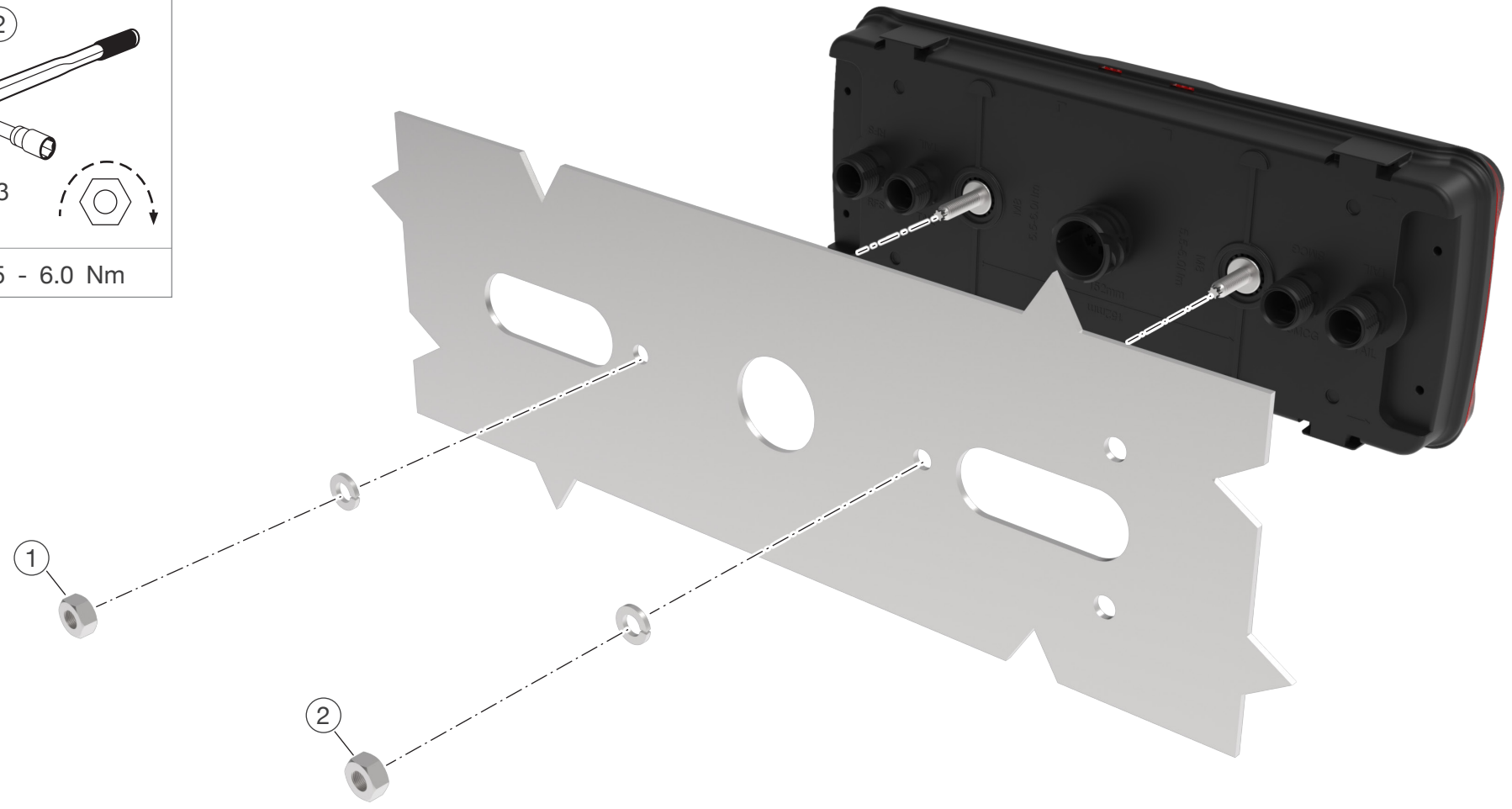



ASPÖCK STECKSYSTEM 2 (ASS2) ASPÖCK CONNECTOR SYSTEM 2 (ASS2)



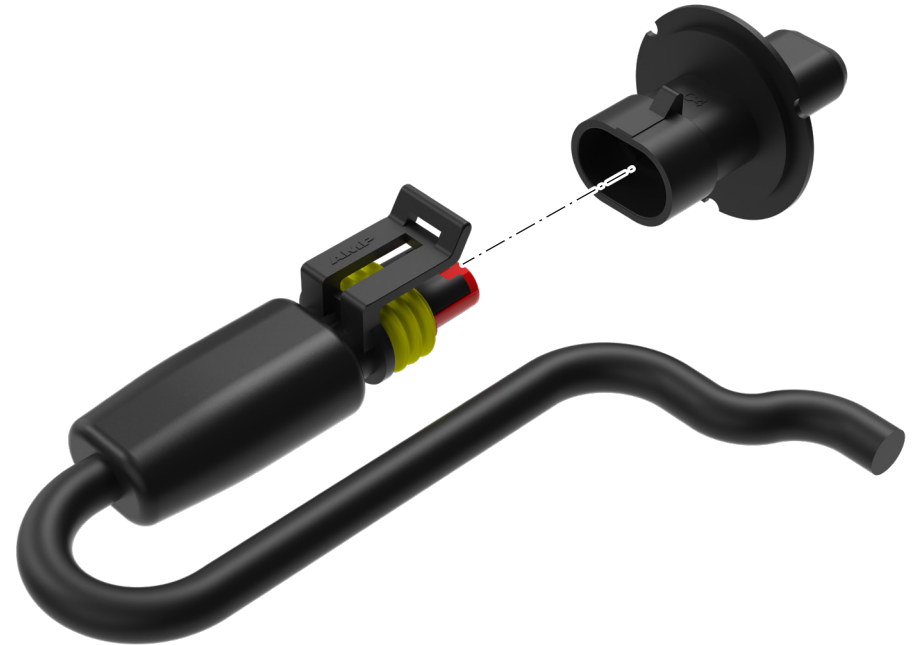

SUPERSEAL SUPERSEAL





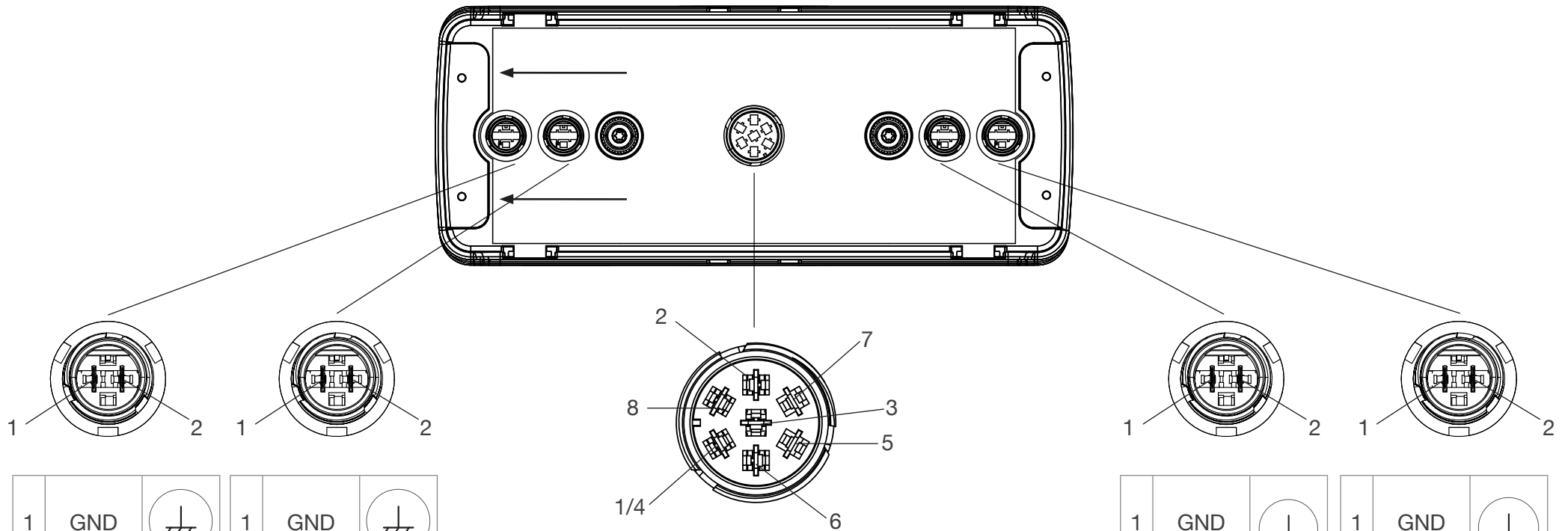



ANSCHLÜSSE ASS2 RH CONNECTORS ASS2 RH



1	GND	
2	Tail	
max. 5A		

1	GND	
2	Tail (SMCG)	
max. 3A SMCG 		

1/4	2	3	5	6	7	8
DI RH	Fog	GND	-	Stop	Tail RH	Reverse
			-			

1	GND	
2	Tail	
max. 5A		

1	GND	
2	Reverse	
max. 5A		



ANSCHLÜSSE ASS2 LH CONNECTORS ASS2 LH

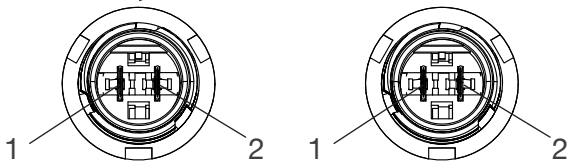
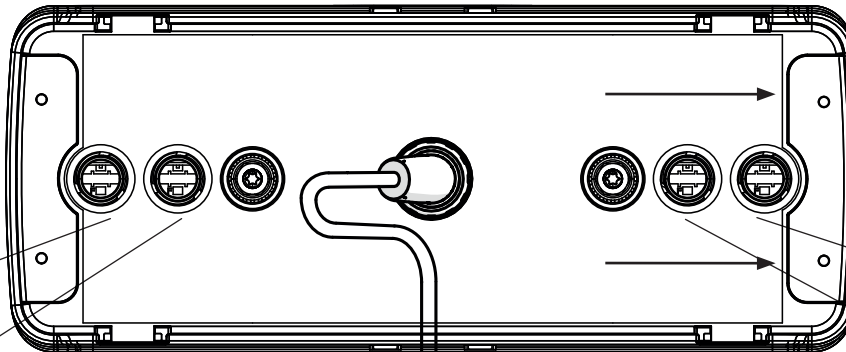

1	GND	
2	Reverse	
max. 5A		

1	GND	
2	Tail	
max. 5A		

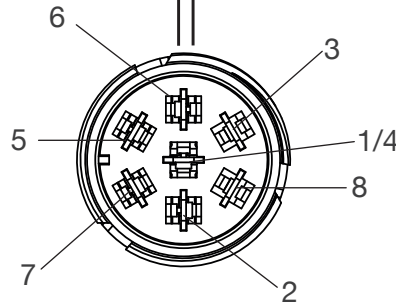

1/4	2	3	5	6	7	8
DI LH	Fog	GND	-	Stop	Tail LH	Reverse
			-			

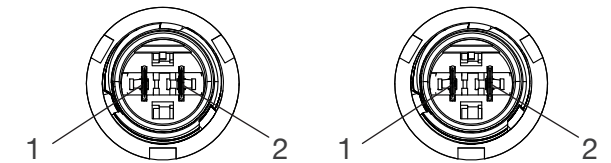

1	GND	
2	Tail (SMCG)	
max. 3A SMCG		

1	GND	
2	Tail	
max. 5A		



ANSCHLÜSSE DIN RH CONNECTORS DIN RH

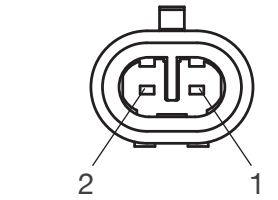
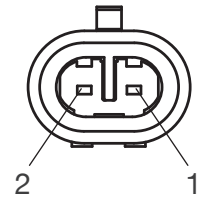
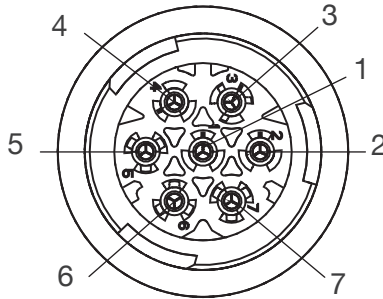
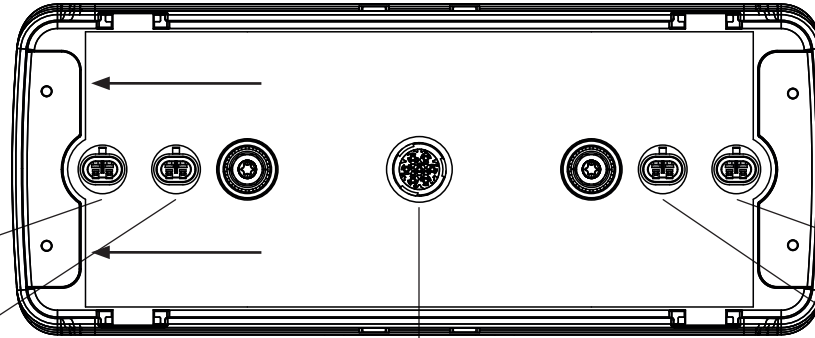

1	GND	
2	Tail	
max. 5A		

1	GND	
2	Tail (SMCG)	
max. 3A SMCG		

1	2	3	4	5	6	7
GND	Tail RH	Reverse	DI RH	Stop	Fog	-
						-

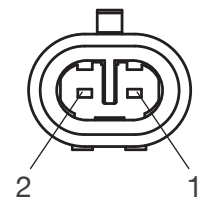
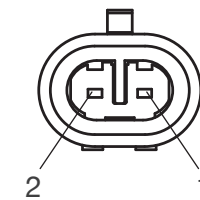



1	GND	
2	Tail	
max. 5A		



1	GND	
2	Reverse	
max. 5A		

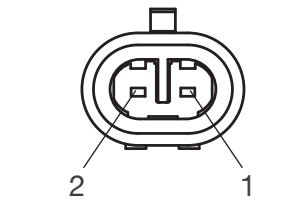
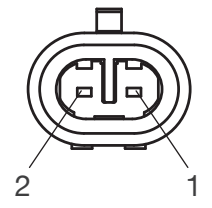
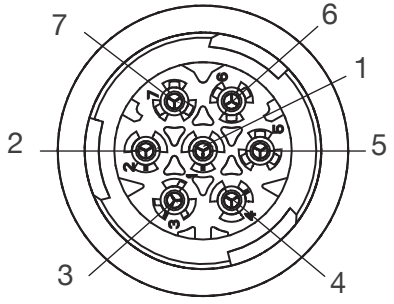
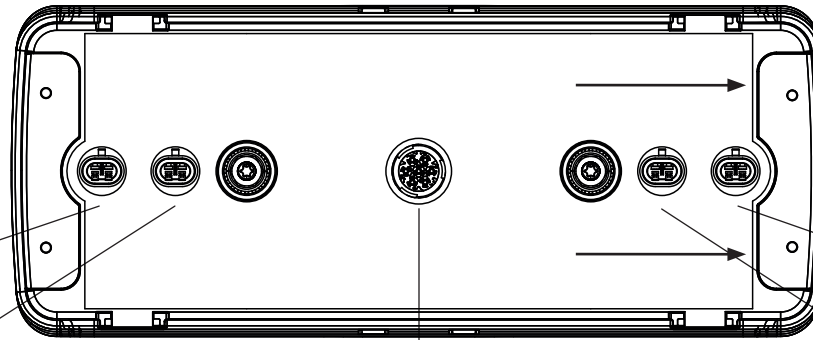







ANSCHLÜSSE DIN LH CONNECTORS DIN LH





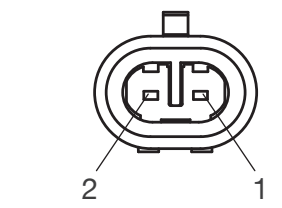
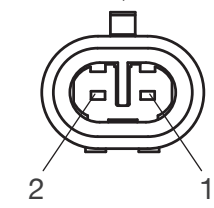

1	GND	
2	Reverse	
max. 5A		

1	GND	
2	Tail	
max. 5A		

1	2	3	4	5	6	7
GND	Tail LH	Reverse	DI LH	Stop	Fog	-
						-



1	GND	
2	Tail (SMCG)	
max. 3A SMCG		

1	GND	
2	Tail	
max. 5A		



ERSATZTEILE SPARE PARTS

18-8536-001
Lichtscheibe Trailer
Lens trailer

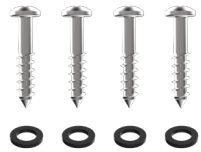
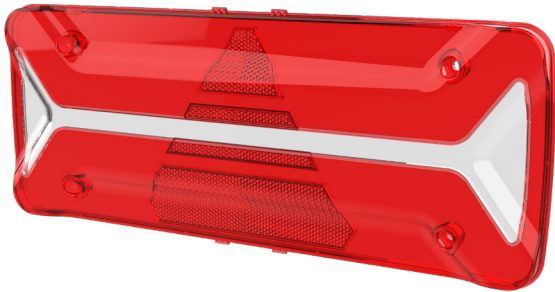

18-8536-011
Lichtscheibe Truck
Lens truck

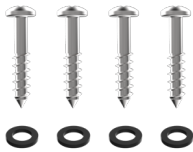

15-5300-294
Adapter
Adapter



31-3103-204
Adapter + SPIV ASS2 LH + Schrauben
Adapter + SPIV ASS2 LH + screws

31-3102-204
Adapter + SPIV ASS2 RH + Schrauben
Adapter + SPIV ASS2 RH + screws

31-3103-214
Adapter + SPIV SS LH + Schrauben
Adapter + SPIV SS LH + screws

31-3102-214
Adapter + SPIV SS RH + Schrauben
Adapter + SPIV SS RH + screws





INFORMATIONSTEXT INFORMATION TEXT

Im Zusammenhang mit diesen geringen elektrischen Leistungen, die sich deutlich von einer Glühlampenversion unterscheiden, kann es beim Betrieb an verschiedenen Zugfahrzeugen zu Problemen bei der Glühlampenausfallkontrolle kommen. Da die Kontrolle der Blinkleuchten gesetzlich vorgeschrieben ist, ist die Leuchte mit einem ISO 13207 Impuls ausgestattet. Darüber hinaus werden von einigen Zugfahrzeugen weitere Lichtfunktionen detektiert. Dies stellt eine Komfortfunktion des Fahrzeugs dar, die nicht gesetzlich vorgeschrieben ist und den Fahrer nicht von seiner Verpflichtung zur visuellen Kontrolle der Beleuchtungseinrichtung befreit. Auch hier kann es durch die geringen Leistungen zu Fehldiagnosen kommen (Instrumententafel im Fahrerhaus zeigt einen Lampenausfall an, obwohl die Funktion gegeben ist). Die Funktionsfähigkeit dieser Lampenausfallkontrollen ist ausschließlich durch den Fahrzeughersteller feststellbar. Im Falle einer fahrzeugseitigen Strombegrenzung in Höhe der obigen Vorgabe durch das fahrzeugseitige Steuergerät, kann auf eine zusätzliche Sicherung für die Leuchte verzichtet werden. Der Betrieb der Leuchte mit Wechselspannung oder getakteter Gleichspannung ist nicht zulässig!

In connection with these low electric powers, which are very different from bulb versions, there can be problems with the bulb failure check during operation on various traction vehicles. Since indicator failure checks are required by legislation, we integrate an ISO 13207 impulse. In addition, further lighting functions are detected by some traction vehicles. This is a vehicle comfort function which is not required by legislation and does not release drivers from their obligation to see for themselves that the lighting equipment is working. Here, too, faulty diagnoses can be a result of the lower power levels involved (instrument panel in the driver cab indicates a bulb failure although the function is working). The functional ability of these light failure checks can only be established by the vehicle manufacturer. If the control unit in the vehicle can restrict the current to match the above requirement, additional fuse protection is not required for the lamp. Operation of the light with alternating current or pulsed direct current is not permitted! The functional ability of these light failure checks can only be established by the vehicle manufacturer.



PFLEGEANLEITUNG CARE INSTRUCTION

Lichtscheibe:

- Abspülen unter fließendem Wasser
- Bei Bedarf ein wenig Spülmittel (kein Scheuermittel!) verwenden
- Mit einem weichem Tuch oder Schwamm säubern und anschließend trocknen
- Kein Mikrofasertuch oder Scheuerschwamm verwenden

Lens:

- Rinse under running water
- Use a little detergent if necessary (not a scouring agent!)
- Clean with a soft cloth or sponge and then dry
- Do not use a microfibre cloth or scouring pad!

Beleuchtungsanlage auf einwandfreie Funktion hin prüfen. Bei Fragen oder Einbauproblemen den Aspöck-Kundendienst, einen Händler oder die Vertragswerkstatt kontaktieren. Kondensation und kleine Wassertropfen an der Lichtinnenscheibe sind kein Problem.

Check that the lighting system is working perfectly. If you have any questions or installation problems, please contact Aspöck customer service, a dealer or the authorised workshop. Condensation and small drops of water on the inner lens are no problem.

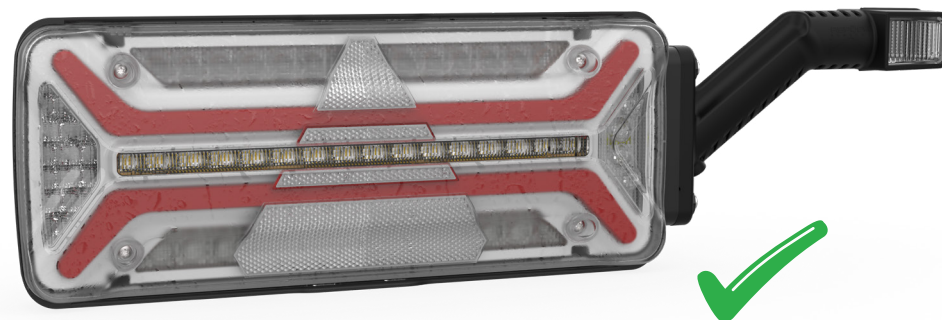



HAFTUNGSBESTIMMUNGEN LIABILITY PROVISIONS

Allgemeines:

- Nationale Anbau-, Einbau- und Betriebsvorschriften sind einzuhalten.
- Eine Verwendung darf ausschließlich gemäß beigelegten Anleitungen und Sicherheitshinweisen erfolgen. Anleitungen sind online auf der Website unter www.aspoeck.com zu finden.
- Änderungen am Produkt dürfen nicht vorgenommen werden, es sei denn es werden ausschließlich die hierfür vorgesehenen Original-Ersatzteile oder von Aspöck freigegebene Ersatzteile verwendet und von fachlich qualifiziertem Personal eingebaut.

Gewährleistungsausschluss:

- Bei Nichtbeachtung der in dieser Montageanleitung sowie der in dem Produktdatenblatt, angegebenen Hinweise und Informationen, bei nicht bestimmungsgemäßem Gebrauch, bei Einsatz außerhalb des vorgesehenen Verwendungszweckes bzw. außerhalb der vorgesehenen Einsatzbedingungen, ist die Gewährleistung für sämtliche Schäden am Produkt ausgeschlossen.
- Die Gewährleistung erstreckt sich weiters nicht auf Produkte, welche aufgrund von Gefahren (einschließlich Umweltgefahren, Gefahren im Straßenverkehr oder durch Dritte verursachte Gefahren oder Umstände, die außerhalb der Kontrolle von Aspöck liegen) beschädigt wurden oder sich in einem schlechten Betriebszustand befinden.
- Die Reparatur oder der Austausch eines mangelhaften Produktes löst nicht den Beginn einer neuen Gewährleistungsfrist aus.
- Weitere Gewährleistungsbestimmungen sind im Punkt 10 der Verkaufs- und Lieferbedingungen (VLB) www.aspoeck.com zu finden.

Haftungsausschluss:

- Aspöck Systems übernimmt keine Haftung für mittelbare Schäden, Folgeschäden und Vermögensschäden.
- Weitere (limitierende) Haftungsbestimmungen sind im Punkt 11 der Verkaufs-, und Lieferbedingungen (VLB) www.aspoeck.com zu finden.
- Limitierende Bestimmungen zur Produkthaftung sind im Punkt 12 der Verkaufs-, und Lieferbedingungen statuiert (VLB) www.aspoeck.com.

General information:

- National mounting, installation and operating regulations must be observed.
- The product may only be used in accordance with the enclosed instructions and safety notes. Instructions can be found online at www.aspoeck.com.
- No modifications may be made to the product unless only the original spare parts intended for this purpose or spare parts approved by Aspöck are used and installed by professionally qualified personnel.

Exclusion of warranty:

- Warranty for any product damage is excluded in the event of non-compliance with the instructions and information given in these installation instructions and in the product data sheet, in the event of use outside of that intended, outside the intended purpose or outside the intended operating conditions.
- The warranty also does not cover products that have been damaged or are in poor operating condition due to hazards (including environmental hazards, road traffic hazards, hazards caused by third parties or circumstances beyond the control of Aspöck).
- Repair or replacement of a defective product does not result in the start of a new warranty period.
- Other warranty provisions can be found in item 10 of the Terms of Sales and Delivery (TSD) www.aspoeck.com.

Exclusion of liability:

- Aspöck Systems accepts no liability for indirect damage, consequential damage and financial losses.
- Other (limiting) liability provisions can be found in item 11 of the Terms of Sales and Delivery (TSD) www.aspoeck.com.
- Limiting product liability provisions are laid down in item 12 of the Terms of Sales and Delivery (TSD) www.aspoeck.com.



THE ART OF LIGHTS

ASPÖCK Systems GmbH

Enzing 4, 4722 Peuerbach, AUSTRIA

Office: +43 7276 2670-0

E-Mail: office@aspoeck.com



aspoeck.com

